



ENERGY STORAGE



**BYHV-230SAC**

# Energy Storage System User Manual

## ZHEJIANG BENYI NEW ENERGY CO.,LTD.

SHUANGHUANLOU INDUSTRIAL ZONE, BEIBAIXIANG YUEQING, ZHEJIANG P.R.CHINA  
TEL: +86-577-5717 7008 FAX: +86-577-5717 7007

✉ info@beny.com

🌐 www.beny.com

♻️ This catalogue has been printed on ecological paper.

© Zhejiang Benyi New Energy Co., Ltd. All rights reserved.

⚠️ If the models and specifications in this product catalogue change due to product updates, we will not provide prior notification.

Importer:xxxxxxx

Address:xxxxxxx



VERSION: 20240507-01

# Table of Contents

## 1. Preface

1.1 Introduction of manual	05
1.2 Audiences	05
1.3 Instructions of symbols	05
1.4 Revision history	05

## 2. Safety Instructions

2.1 Safety precautions	05
2.2 Safety requirements	06
2.2.1 Storage and transportation	06
2.2.2 Unpacking acceptance	06
2.2.3 Product installation	07
2.2.4 Product connection	07
2.2.5 Power-on	07
2.2.6 Operation	08
2.2.7 Maintenance	08
2.2.8 Maintenance and repair	08
2.2.9 Scrap	08

## 3. Product Description

3.1 Introduction of product	09
3.2 Principle	09
3.3 Basic characteristics	10
3.4 Model description	10
3.5 Product specification	10
3.6 Structural layout	11
3.7 Description of components	12
3.7.1 Battery pack	13
3.7.2 Battery management system (BMS)	13
3.7.3 Power Conversion System (PCS)	15
3.7.4 Energy Management Unit (EMU)	15
3.7.5 Fire fighting system	18
3.7.6 Temperature control system	19
3.8 Product dimensions	19

# Table of Contents

<b>4. Transportation and Installation</b>	
4.1 Receiving inspection	20
4.2 Storage	20
4.3 Carrying	20
4.3.1 Carrying with forklift	21
4.3.2 Lifting	21
4.4 Installation of equipment	22
4.4.1 Safety tips	22
4.4.2 Environmental requirements of installation	22
4.4.3 Site requirements of installation	23
4.4.4 Space requirements of installation	24
4.4.5 Installation equipment	25
4.5 Electrical installation	26
4.5.1 Instructions of connection terminals	26
4.5.2 Description of communication interface	26
4.5.3 Safety precautions	27
4.5.4 Cable fabrication	27
4.5.4 Cable connection	28
<b>5. Debugging and Operation</b>	
5.1 Pre-operation inspection	30
5.2 Start steps	30
5.3 Stop steps	31
5.4 Recommend charging method	31
5.5 Lighting Board Mode	31
<b>6. Interface Operation Instructions</b>	
6.1 Main interface	32
6.1.1 Energy storage system status	32
6.1.2 Topology of a stacked system (computing)	34
6.1.3 Power curve	35
6.1.4 Warning info	36
6.2 Subsystem cabinet details interface	37
6.3 Parameter settings	39
6.4 Energy management settings	41
6.4.1 Temperature gradient limit control strategy	41
6.4.2 Voltage gradient limit control strategy	42
6.4.3 Cell voltage limit control strategy	43
6.4.4 PCS limit control strategy	43
6.4.5 Static demand control setting	44
6.4.6 Anti-reverse current control setting	45
6.5 Air-conditioning equipment	45

<b>6. Interface Operation Instructions</b>	
6.6 Device settings	46
6.6.1 ESMU setting	46
6.6.2 Password setting	47
6.6.2 Time setting	47
6.6.4 History logging	48
6.6.5 About system	48
<b>7. Troubleshooting</b>	
7.1 Fault Diagnosis Table	49
7.2 Frequently asked questions	51
<b>8. Regular Maintenance</b>	
8.1 Precautions before maintenance	52
8.2 List of Maintenance Items and Cycles	52
8.2.1 Daily routine inspection and maintenance items	52
8.2.2 Semiannual maintenance items	53
8.3 Maintenance of cabinet	53
8.3.1 Clean surface of box free of dust	53
8.3.2 Scratches on the surface of box	54
8.3.3 Paint shedding of box	54
8.3.4 Inspection of door locks, hinges and sealing strips	54
8.4 Maintenance of equipment	54
<b>9. Appendices</b>	
A. Technical Parameters	55
B. Quality assurance	56



# 1. Preface

## 1.1 Introduction of manual

This manual presents the functions and operating methods of BYHV-230SAC air-cooled energy storage system, including the related instructions and precautions for the product installation, parameter setting, field debugging, fault diagnosis, regular maintenance, etc.

Please keep the manual at an accessible place.

Be sure to read this manual and get acquainted with the safety precautions before the operation.

The diagrams in this manual are for reference only, and the product in kind shall prevail.

## 1.2 Audiences

This manual is for use only by the electrically certified operators, and the operations described in the manual shall be executed and performed by the trained and experienced electricians according to the basic electrical safety protection regulations.

## 1.3 Instructions of symbols

The safety symbols in this manual as shown in the following table are used to remind readers of the safety precautions for installing, operating and maintaining the equipment.

### Definition of safety levels



"Danger" means a highly potentially dangerous situation that, if not avoided, could lead to death or serious injury.



"Warning" means a moderately potentially dangerous situation that, if not avoided, may result in death or serious injury.



"Caution" means a low-risk situation that, if not avoided, may result in minor or moderate injury.



Due to the presence of high voltage in the cabinet, be sure to cut off all power supplies before the maintenance. Only when it is determined that the energy storage devices such as capacitors in the equipment are powered off can the energy storage system be operated by professionals.

## 1.4 Revision history

Date	Version	Revision
2024.03	A01	First edition

# 2. Safety Instructions

## 2.1 Safety precautions

- This chapter explains the safety precautions for operating this product correctly. Before operating this product, please read this manual and correctly understand the safety precautions. Failure to comply with the safety precautions may result in the death, serious injury or equipment damage.
- "Dangers", "Warnings" and "Cautions" in this manual do not represent all safety precautions to be observed but only supplement all safety precautions.



- This product shall be used in the environment in line with the design specifications, otherwise the failure may be caused, and the resulting equipment abnormality or component damage may not be covered by the product warranty.
- Our company disclaims any legal liability for any personal safety accident and property loss caused as a result of non-compliance with this manual and operation of products not following the regulations.

### Our company assumes no responsibility under situations as following:

- Operation beyond the conditions of use described in this manual.
- Installation and use environment not in line with relevant international or national standards.
- Unauthorized disassembly, modification of products or modification of software codes.
- Failure to follow the operation instructions and safety warnings of the product and manual.
- Equipment damage caused by abnormal natural environment (force majeure, such as earthquake, fire, storm, etc.).
- Damage during the transportation arranged by customer.
- Damage caused by storage conditions inconsistent with the requirements of this manual.

## 2.2 Safety requirements

Illustrations of product in this manual are sometimes used to show the details of the product with the cover or shelter removed.

Be sure to fit the cover or shelter as required before operating this product, and operate the product according to the regulations of manual.

The illustrations in this manual are only for reference and may differ slightly from the product in kind you ordered. The product actually ordered shall prevail.

### 2.2.1 Storage and transportation



The large or heavy products shall be carried by qualified professionals with professional lifting equipment. Otherwise, injury or product damage may be caused!

Before lifting the product vertically, please make sure that the front cover, terminal block and other components of the product have been fixed firmly with screws. Otherwise, the components may fall off and cause personal injury or product damage!

When the product is hoisted by lifting equipment, do not stand or stay under the product.

When lifting the product with steel wire rope, please lift it steadily at a constant speed, prevent the product from vibration or impact, do not turn over the product, and do not get the product lifted for a long time. Otherwise the personal injury or product damage may be cause



When carrying the product, lift it lightly and be aware of the objects under your feet at any time to prevent tripping or falling. Otherwise the injury or product damage may be caused!

Please strictly follow the requirements for the storage and transportation. Otherwise the product damage may be caused.

Do not store and transport the product at places with water splashing and rain, direct sunlight, strong electric field, strong magnetic field and strong vibration.

Do not store the product for more than 3 months. For the long-term storage, please carry out stricter protection and necessary inspection.

Please pack the product strictly before transporting it by truck, and select the closed box for long-distance transport.

Do not transport this product together with equipment or articles that may affect or damage this product.

### 2.2.2 Unpacking acceptance



Do not install the unpacked product if the product itself or its accessories are damaged, rusted and used!

Do not install the unpacked product in case of the ingress of water, and missing or damage of parts!

Please check the packing list carefully. Do not install the product if the packing list is not consistent with the product name!



Before unpacking, please check whether the outer package of equipment is intact and check it for any damage, soak, damp or deformation. Please open the package from outside to inside, and do not knock at the package violently!

When unpacking, please check the surface of equipment and accessories for damage, corrosion, bump, etc.

After unpacking, please carefully check if the equipment, accessories and information are complete against the packing list.

### 2.2.3 Product installation



The product can only be operated by the professionals with the electrical knowledge who have received relevant training in electrical equipment. The product shall not be operated by the non-professional personnel!



Please read the manual and safety precautions carefully before the installation!

Do not install this product in places with strong electric field or electromagnetic wave interference!

Before the installation, ensure that the mechanical strength of the mounting position is sufficient to support the weight of equipment. Otherwise the mechanical risk may be caused.

Do not wear loose clothes or accessories when installing the product. Otherwise the electric shock may be caused!

When installing the product in a closed space (such as the cabinet or chassis), be sure to cool it adequately with a cooling device (such as a cooling fan or a cooling air conditioner) to meet the requirements of installation environment. Otherwise the product may overheat or a fire may be caused.

Do not modify this product!

Do not screw the fixing bolts and red-marked bolts of parts and components!

When this product is installed in the cabinet or terminal equipment, the cabinet or terminal equipment shall be provided with the corresponding protective devices such as fire, electrical and mechanical protection shells with the IP grade in line with the relevant IEC standards and local laws.

Please install a shielding protection device when the equipment with strong electromagnetic interference such as transformer to avoid the misoperation of this product!

Please install the product on flame retardant materials such as metal. Do not make flammable materials contact with the product or attach flammable materials to the product. Otherwise the fire may be caused.

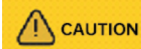

During installation, please cover the air inlet and outlet of the product with cloth or paper to prevent the fault caused by the foreign bodies such as metal chips, oil and water during the drilling process. After the operation, please remove the shelter to prevent the abnormal heating caused by the blockage of vents and the resulting reduced heat dissipation.

### 2.2.4 Product connection



Do not allow non-professionals to install, wire, maintain, inspect, or replace components of the equipment.

Please cut off the power supply of all equipment before connection. Voltage remains at the internal capacitor of the equipment after the power supply is cut off. Please conduct the connection and other operations at least the time specified by the warning label on the product later. Measure the DC voltage of main circuit and make sure it is below the safe voltage. Otherwise the electric shock may be caused.

Be sure to cut off the power supply before the connection, cover removal or touching of circuit board. Otherwise the electric shock may be caused.

Please ensure that the equipment and products are well grounded. Otherwise the electric shock may be caused.



Do not connect the input power supply to the output of equipment or product. Otherwise the equipment damage or even fire may be caused.

Ensure that the cables used for wiring meet the specified wire diameter and shielding requirements. Properly ground the shielding layer of shielded cables at one end!

Please tighten the terminal screws according to the tightening torque specified in the manual. Insufficient or excessive tightening torque may cause overheating and damage of the connection and even the fire hazard.

After the connection, make sure all cables are connected correctly and there are no dropped screw, gasket or bare cable inside the product. Otherwise the electric shock or damage may be caused.



Please follow the specified electro-static discharge (ESD) procedures, and wear antistatic wrist strap for connection and other operations to avoid damaging the internal circuits of equipment or product.

For the connection of control circuit, please connect the shielding layer to the grounding terminal of the product for grounding with double-stranded shielding cables. Otherwise the anomaly may be caused.



### 2.5 Power-on



Before power-on, make sure that the product is installed and connected properly and firmly.

Before power-on, confirm that the power supply meets the product requirements to avoid the damage or fire!

Do not open the cabinet door or protective cover plate, touch any terminal, or disassemble any device or part under the power-on status. Otherwise the electric shock may be caused!



After the connection and parameter setting, conduct the test run of the machine to ensure that the machine can act safely. Otherwise the personal injury or equipment damage may be caused.

Before the power-on, ensure that the rated voltage of product is consistent with the supply voltage. The incorrect supply voltage may cause the fire.

Before the power-on, ensure no people around the product and machine. Otherwise the personnel injury or death may be caused.

### 2.2.6 Operation



The product shall be operated by professionals. Otherwise the personnel injury or death may be caused!

Do not touch any terminal, or disassemble any device or part under the power-on status. Otherwise the electric shock may be caused!



Do not touch the equipment shell, fan or resistor to test the temperature. Otherwise the burns may be caused!

During the operation, prevent other items or metal objects from falling into the equipment. Otherwise the fire or product damage may be caused!

### 2.2.7 Maintenance



Do not allow non-professionals to install, wire, maintain, inspect, or replace components of the equipment!

Do not maintain the live equipment. Otherwise the electric shock may be caused!

After powering off all equipment, please conduct the maintenance at least the time specified by the warning label on the product later.



Please carry out the daily and regular inspection and maintenance according to the maintenance requirements, and make maintenance records.

### 2.2.8 Maintenance and repair



Do not allow non-professionals to install, wire, maintain, inspect, or replace components of the equipment

Do not repair the live equipment. Otherwise the electric shock may be caused!

Be sure to shut down the machine before the repair, and then perform maintenance or overhaul on the equipment after confirming that the energy storage system stops running.

After powering off all equipment, please conduct the inspection and repair at least the time specified by the warning label on the product later.

Even if all the external circuits are disconnected, there is still a high voltage between the positive and negative electrodes of the energy storage battery group, and some parameters shall be measured when the system is charged. The test should be conducted by the professionals with special instruments.

Do not modify the internal equipment of battery system to avoid the risk.



Please request for repair according to the product warranty agreement.

When the fuse is blown, circuit breaker or earth leakage circuit breaker (ELCB) trips, please power on or operate the machine at least the time specified by the warning label on the product later. Otherwise the casualties and equipment damage may be caused.

In case of equipment failure or damage, the equipment and product shall be troubleshot and repaired by professionals according to the repair instructions and the repair record shall be made.

Please follow the instructions to replace the wearing parts.

Do not continue to use the damaged machine. Otherwise the casualties or greater damage to the product may be caused.

After replacing the equipment, please re-check the equipment connection and set the parameters.

### 2.2.9 Scrap



Please scrap equipment and product according to relevant national regulations and standards, so as not to cause property losses or casualties!

Dispose of the scrapped equipment and products in accordance with the standards for industrial waste disposal, to prevent environmental pollution.

### 3. Product Description

#### 3.1 Introduction of product

Based on the "ALL-IN-ONE" design, BYHV-230SAC air-cooled energy storage system is integrated with the cell, BMS, PCS, EMS, thermal management system, fire fighting system and power distribution, and the design of single string can prevent the capacity loss for multi-machine parallel connection.

BYHV-230SAC air-cooled energy storage system is integrated with harmonic control, reactive power compensation and three-phase imbalance control, and can perform the peak load shifting, peak and frequency modulation, etc. Multiple groups of cabinets can be directly connected in parallel to realize the expansion of energy storage system conveniently and quickly. The product supports the on-grid and off-grid modes and is suitable for a variety of scenarios.

#### 3.2 Principle

Schematic of Main Circuit

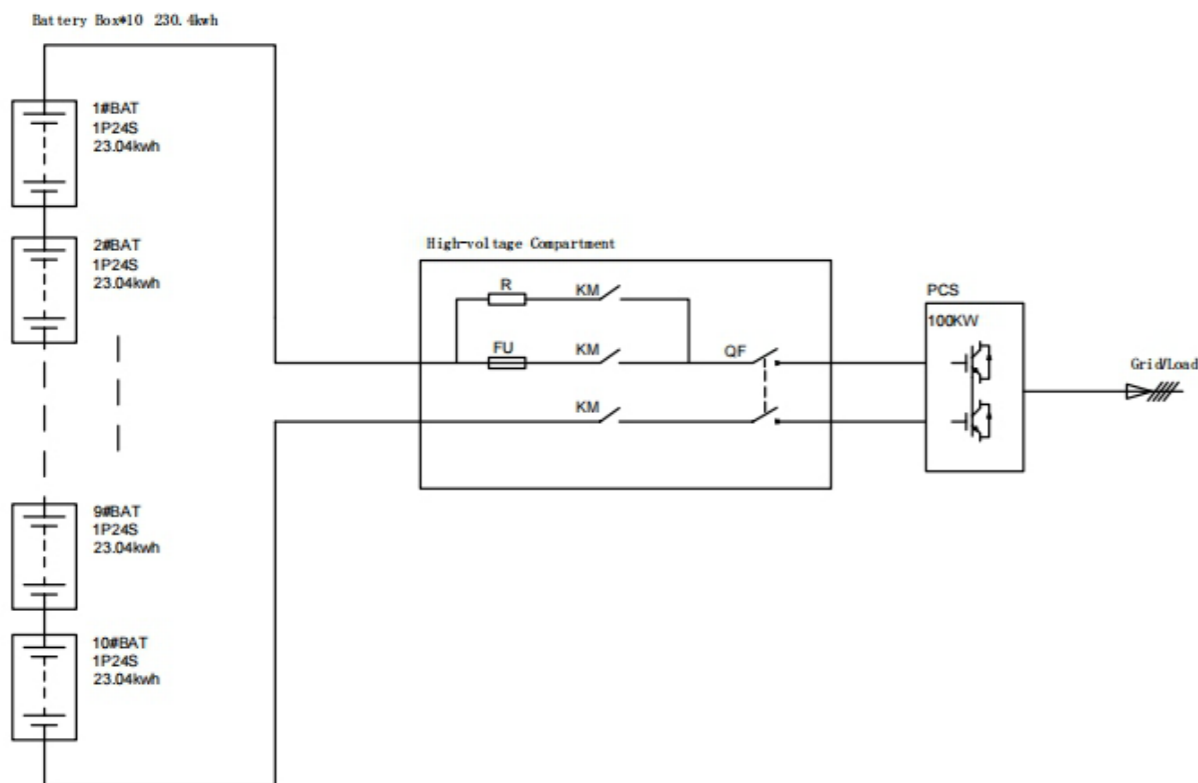

#### Working mode

BYHV-230SAC air-cooled energy storage system supports the on-grid and off-grid modes.

##### ●On-grid mode

The AC side of energy storage system is connected with grid, and DC side is internally connected with a lithium battery. It can be applied to power expansion, integrated PV storage and charging system, peak load shifting, etc. Lithium battery can be charged and discharged at constant voltage, current and power depending on the selected mode.

##### ●Off-grid mode

The DC side of energy storage system is connected with lithium battery, and the system can output three-phase AC voltage with fixed frequency and RMS, thus powering up the load at AC side continuously.

#### 3.3 Basic characteristics

##### ●Standard design

Modular "All-In-One" design is integrated with single cabinet and featured with the integrated transportation, convenient shipment and easy operation & maintenance

##### ●High safety

Multi-level fire fighting system, isolation linkage protection at different levels and circulating air duct design ensure the safe and stable operation

##### ●Intelligent and efficient

Mature energy management strategy and equipment control, intelligent operation and maintenance, and remote control can maximize the product value

##### ●Flexible and easy installation

Multi-level parallel connection and bottom convergence design can maximize the use of land space

#### 3.4 Model description

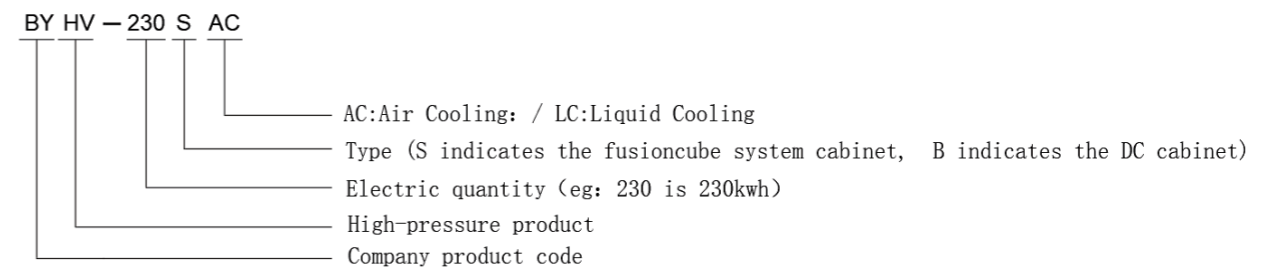

### 3.5 Product specification

Item	Specification
<b>DC parameter</b>	
Battery type	300Ah, LFP battery
Group mode of battery	1P240S (1P24S*10)
Rated capacity of battery	230.4kWh
Rated voltage of battery	768V
Battery voltage range	628V~855V
Rated charge and discharge current	150A
Cycles	≥8,000 (25°C, 0.5C, 80%DOD)
<b>AC side (on-grid)</b>	
Rated power	100kW
Rated voltage	AC380V to 415V
Rated current	150A
Rated frequency	50Hz/60Hz
Power factor	0.99
Output harmonic	< 3%
Access mode	3P+N+PE
Isolation mode	Non-isolation
<b>AC side (off-grid)</b>	
Rated power	100kW
Rated voltage	AC380V to 415V
Rated current	150A
Rated frequency	50Hz/60Hz
Power factor	0.99
Output harmonic	< 3%
Access mode	3P+N+PE
<b>System parameters</b>	
System energy efficiency	≥90%
Operation mode	On-grid/off-grid
Communication mode	CAN, 485, TCP/IP
IP grade	IP55
Anti-corrosion grade	C3
Noise	≤65dB
Fire fighting	Hot aerosol
Ambient temperature	-29°C ~ +50°C
Ambient humidity	0~ 95%(no condensation)
Altitude	≤2,000m (derated above 2,000m)
Cooling mode	Intelligent air cooling
Overall size (W*H*D)	1130mm*2050mm*1865mm
Weight	About 2.6t

Table 3-1 Electrical Specification Parameters

### 3.6 Structural layout

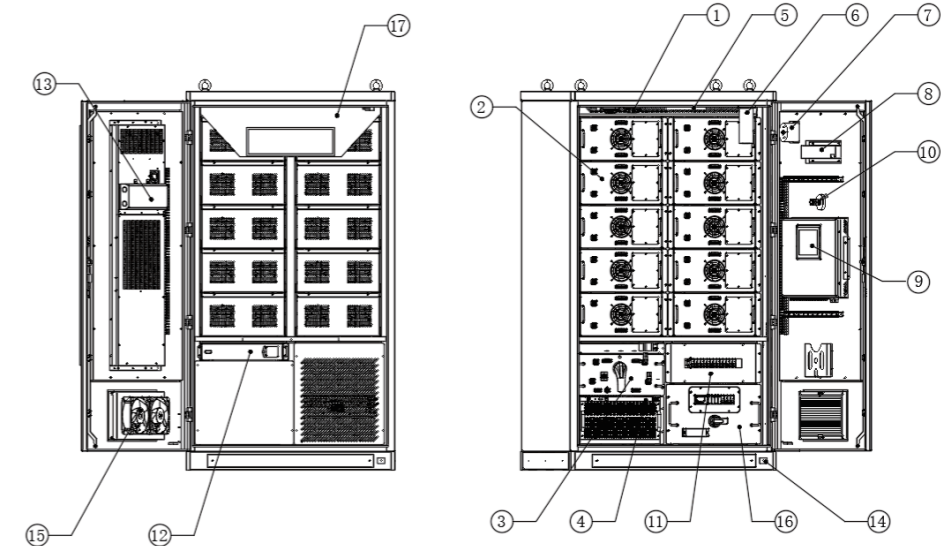

Fig.3-1 Schematic of Structural Layout

S/N	Name	Description
①	Temperature/smoke sensor	As a fire fighting system component, detect the temperature inside the box, when the temperature or smoke reaches the warning limit, ⑥ will be triggered to spray the gaseous aerosol, ⑦ acousto-optic alarm will flash and sound, and report to the display and control module ⑨ to show the alarm status
②	Battery pack	24 strings of 300Ah lithium iron phosphate cells and battery management unit (BMU) inside will collect the voltage and temperature information of cells and upload it to battery control unit (BCU)
③	High-voltage box	Battery control unit (BCU), circuit breaker, contactor, fuse and other components will manage, control, protect and monitor the cells
④	PCS	50KW power conversion system (PCS) will exchange the energy between battery group and grid through AC and DC bidirectional conversion
⑤	Lamp	No separate switch is required, cooperate with access control. When the door is opened, light up, and turn off when it is closed
⑥	Aerosol fire extinguisher	As a fire fighting system component, interact with ① temperature/smoke sensor and ⑦ acousto-optic alarm and report to display and control module, and after triggering, acousto-optic alarm will flash and sound
⑦	Acousto-optic alarm	As a fire fighting system component, flash and sound after the spraying signal is issued
⑧	Indicator bar	Communicate with display and control module, display the operation fault alarm status and remaining capacity of SOC.
⑨	EMU display and control module	As an energy management system, schedule and monitor the energy of energy storage system
⑩	Emergency stop switch	When the equipment is abnormal, press the button that the system stops running
⑪	Distribution box	External incoming and outgoing interfaces, electric quantity monitoring and independent control switch of each component power supply
⑫	UPS	Uninterruptible Power Supply
⑬	Air conditioner	Mainly regulate the temperature of battery and turn on/off the machine under the control of EMU
⑭	Touch down point	Connection to external earth
⑮	Exhaust fan	Bringing out the heat from the heat-generating devices in the cabinet
⑯	Debugging communication port	External PC connection for commissioning and monitoring of equipment

S/N	Name	Description
⑰	Exhaust air duct	Internal circulation ducts for air conditioning to dissipate battery heat

Table 3-2 Description of Components

### 3.7 Description of components

#### 3.7.1 Battery pack

The battery pack contains 24 cells, a battery management unit (BMU) and a cooling fan. A battery pack contains 24 NTC temperature sampling probes, and the battery management unit collects the voltage and temperature of the cells and uploads it to the battery management unit.

Slave control unit constitutes an important part of energy storage battery management system (BMS), and plays a decisive role in the safe application and life extension of energy storage batteries when they are used in groups. The slave control unit can monitor the real-time status of batteries by accurately collecting the voltage and temperature of each unit battery. The module has reliable data communication function, and can communicate with the main control unit of the battery management system or other necessary equipment during the system operation. High reliable automotive control chip and the latest collection technology with the high accuracy lays a good physical basis for SOC prediction.

Item	Specification	Remarks
<b>Basic parameters</b>		
Number of cells	24 strings	
Rated capacity	23.04KWH	
Voltage range	60V~87.6V	Unit battery voltage range: 2.5V ~ 3.65V
Rated voltage	76.8V	
Rated charge and discharge ratio	0.5P	
Equalization mode	Passive equalization	
<b>Working environment</b>		
Operating temperature of battery pack	Charge: 0 ~ 55 °C; discharge: -20 °C ~ + 55 °C	
Storage temperature	-30°C~+60°C	
Recommended operating temperature	25±3°C	
<b>General parameter</b>		
Auxiliary supply voltage range	18V~36V	DC
Battery pack size	450mm*1205mm*232mm	
Battery pack weight	181.5kg	
Cooling mode	Intelligent air cooling	
Communication mode	CAN	

Table 3-3 Technical Parameters of Battery Pack

#### 3.7.2 Battery management system (BMS)

BMS estimates and monitors the internal status (SOC, SOH, SOP, etc.) of the battery based on the physical model algorithm of the cells by monitoring the voltage and temperature of the unit batteries as well as the external characteristic parameters such as the total voltage, current, temperature and insulation resistance to the ground of battery group.

On this basis, BMS conducts the charge and discharge management, thermal management, insulation detection, unit battery equalization management and fault alarm of battery group system by turning on/off the output switch, so as to prevent the battery from overcharging or over-discharging, make the battery group work in the best status, realize the energy equalization of lithium battery system and prolong the service life of battery.

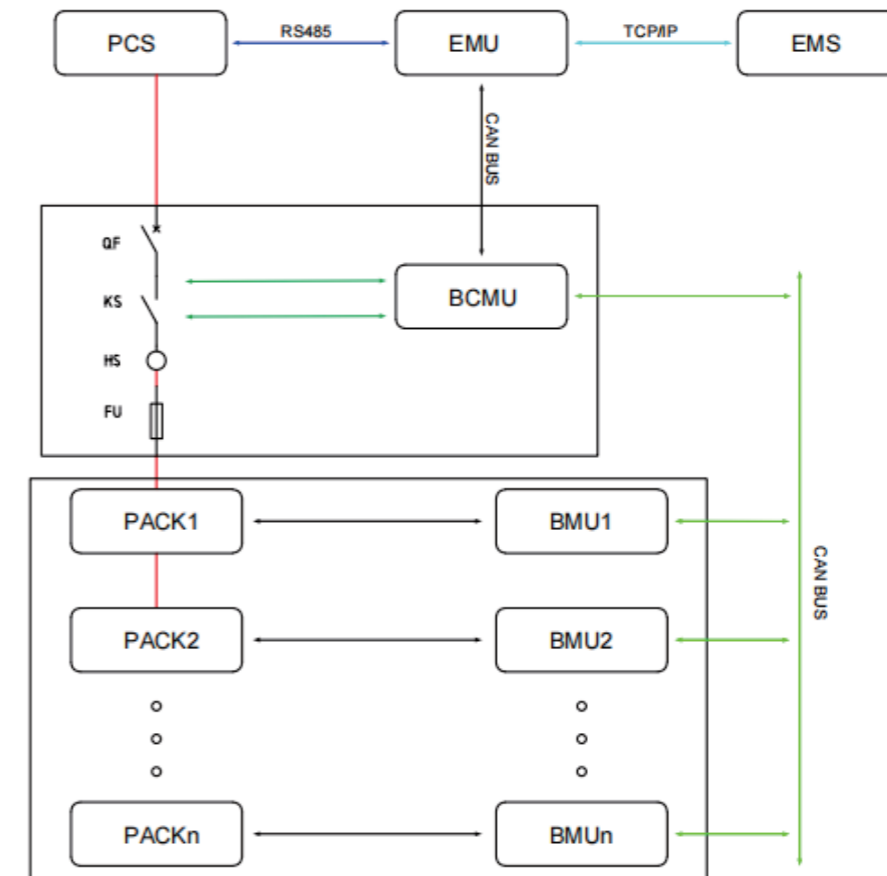

Fig. 3-2 Topology Diagram of Battery Management System

Item	Parameter	Remarks
Rated voltage	9~32Vdc	
5V power output rated voltage	5Vdc	
5V DC power output current	300mA	
12V power supply output rated voltage	12Vdc	
12V DC power output current	300mA	
Group terminal voltage acquisition range	0~1500Vdc	
Group terminal voltage acquisition accuracy	±0.1%FS	
Current acquisition range	0~±500A	
Current acquisition accuracy	±0.1%	
Temperature acquisition range	-40°C~125°C	
Temperature acquisition accuracy	±1°C	
Insulation resistance acquisition range	0~10MΩ	
Insulation resistance acquisition accuracy	15%	

Table 3-4 Parameters of Battery Management System





### 3.7.3 Power Conversion System (PCS)

Power conversion system mainly functions to convert the electric energy between the grid and battery, monitor and manage the exchange process. Power conversion system supports the on-grid and off-grid modes.

Item	Specification
<b>Parameters at DC side</b>	
Voltage range (Vdc)	650~950
Rated voltage (Vdc)	800
Maximum charge/discharge current (Adc)	170
<b>AC on-grid parameters</b>	
Rated power (kW)	105
Rated voltage (V)	230/400, 3P+N+PE
Maximum current (A)	167
Frequency (Hz)	50/60
Power factor	0.99
<b>AC off-grid parameters</b>	
Rated output power (kW)	105
Rated output voltage (V)	230/400, 3P+N+PE
Maximum output current (A)	167
Frequency (Hz)	50/60
Power factor	0.99
<b>General parameter</b>	
Operating temperature	-30°C-55°C (derating for use at > 45°C)
Altitude (m)	5000m (derating for use at an altitude above 3000m)
Grid support	L/HVRT, active and reactive power control
Dimensions (W * D * H) (mm)	484*703*256.5
Weight (kg)	50

Table 3-5 Parameters of Power Conversion System

### 3.7.4 Energy Management Unit (EMU)

Display and control module of EMU energy storage system is the local monitoring and management unit of container energy storage system or distributed energy storage system system. It can collect, display and jointly control the real-time information of various components of energy storage system, conduct the local monitoring protection and energy management, support IEC6180, MODBUS, 104, MQTT and other communication protocols, perform the advanced diagnosis of safe and healthy operation conditions of energy storage system equipment and battery system, and carry out the local intelligent operation and maintenance. It is an intensive, intelligent and integrated low-cost local centralized control management equipment of energy storage system.

EMU is suitable for the integrated centralized monitoring and management of containers, outdoor cabinets and other types of energy storage systems for power supply side, grid side, user side, microgrid, etc.



Interface type	S/N	Port definition	Function description
A	1	V+	Power input (positive)
	2	V-	Power input (negative)
	3	PE	System earthing
LAN	-	LAN0	100M/1000M Ethernet
	-	LAN1	100M/1000M Ethernet
	-	LAN2	10M/100M Ethernet
B	8	VDD	DI Isolated power output (positive)
	16	VSS	DI Isolated power output (negative)
	7	DI1H	High effective digital detection
	15	DI2H	High effective digital detection
	6	DI3H	High effective digital detection
	14	DI4H	High effective digital detection
	5	DI5H	High effective digital detection
	13	DI6H	High effective digital detection
	4	DI7L	Low effective digital detection
	12	DI8L	Low effective digital detection
	3	DI9L	Low effective digital detection
	11	DI10L	Low effective digital detection
	2	DI11L	Low effective digital detection
	10	DI12L	Low effective digital detection
	1/9	DI0+/DI0-	AC (110~220Vac 50Hz) detection
	C	10/9	0A/0B
8/7		DBG_RX	1#RS485
6/5		2A/2B	2#RS485
4/3		3A/3B	3#RS485
2/1		4A/4B	4#RS485
19/17/15/13 /11		RB0~RB4	RS485 terminal resistance; if RB is floating, there is no internal resistance (120R); if RB is short-circuited with xB (0B/1B, etc.), internal resistance
20/18/16/14 /12/10		RG0~RG4	Shielding layer grounding point of each RS485, floating by default
6/5		0H/0L	0#CAN
D	4/3	1H/1L	1#CAN
	2/1	2H/2L	2#CAN
	11/9/7	RL0/RL1/RL2	CAN terminal resistance; if RL is floating, there is no internal resistance (120R); if RL is short-circuited with xL(0L/1L/2L), an internal resistance exists(120R).
	12/10/8	CG0/CG1/CG2	Shielding layer grounding point of each CAN, floating by default

Table 3-6 Parameters of EMU Display and Control Module

Interface type	S/N	Port definition	Function description
E	13/26	D0+/D0-	0# Normally open dry contact output
	12/25	D1+/D1-	1# Normally open dry contact output
	11/24	D2+/D2-	2# Normally open dry contact output
	10/23	D3+/D3-	3# Normally open dry contact output
	9/22	D4+/D4-	4# Normally open dry contact output
	8/21	D5+/D5-	5# Normally open dry contact output
	7/20	D6+/D6-	6# Normally open dry contact output
	6/19	D7+/D7-	7# Normally open dry contact output
	5/18	D8+/D8-	8# Normally open dry contact output
	4/17	D9+/D9-	9# Normally open dry contact output
	3/16	D10+/D10-	10# Normally open dry contact output
F	2/14	NO11/COM	11# Normally open dry contact output
	15/14	NC11/COM	11# Normally open dry contact output
	1	TX	RS232 send port
F	2	RX	RS232 receiving port
	3	GND	RS232 reference ground
	1	USB1	USB Type A (Firmware upgrade port)
F	2	USB0	USB Type A
	-	SW	Auxiliary firmware

Table 3-6 Parameters of EMU Display and Control Module

### 3.7.5 Fire fighting system

The fire fighting system is a interactive system integrating the aerosol device, smoke sensor, temperature sensor and acousto-optic alarm. JAD300-U01 hot aerosol fire extinguisher has super high fire extinguishing efficiency and reliability. This fire extinguisher has the advantages of stable spraying, small volume and pressureless storage, and the extinguishing substance is safe, reliable, non-toxic, harmless and environment friendly.

For the automatic aerosol fire extinguishing system, the fire extinguishing is controlled automatically in the protection area. In this status, when the fire control system receives the fire signal detected by two or more detectors in the same protection area, it will send out a signal to start the JAD300-U01 aerosol fire extinguisher, and then the fire extinguishing system will carry out the following procedures and operations:

- According to the program setting, the controller of the protection area firstly sends out the sound and light alarm in the area, and the emergency evacuation signal;
- After the above operation is completed, the spraying countdown starts according to the delay time set by the program depending on the actual application scene and place;
- During the delay period, all openings, fire doors, heat dissipation vents, air conditioner outlets, etc. in the protection area will be automatically closed according to the design requirements and program settings;
- Send the feedback signals to the fire control system or monitoring system to monitor whether all procedures or actions are running normally;
- Send a fire extinguishing instruction to the fire extinguisher immediately after the end of delay stage;
- Extinguisher will generate a large amount of fire extinguishing medium and spray it into the protection area;
- Meanwhile, send the feedback signal after the aerosol generator reacts, and transmit the signal to the fire control system. The controller sends a linkage signal to light up the gas release indicator lamp at the entrance of protection area to remind personnel not to enter the area;
- Ventilate the protection area after the fire is extinguished, and clean the area synchronously.

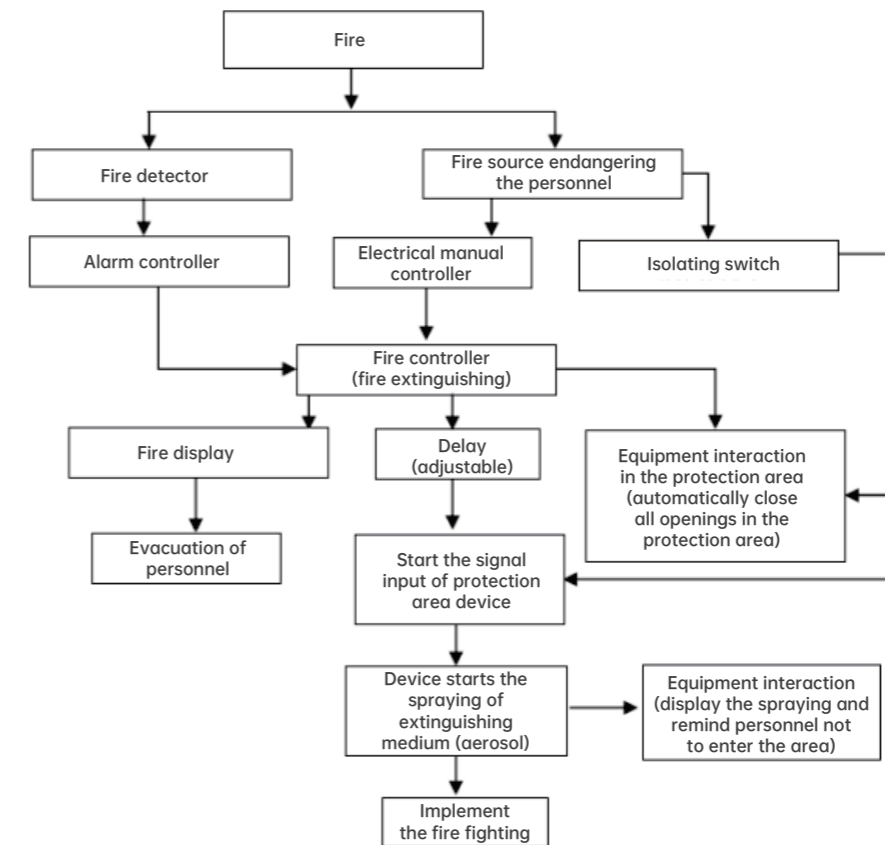

Fig. 3-3 Extinguishing Flow Chart of Fire Fighting System

### 3.7.6 Temperature control system

AC1500 air-cooled air conditioner is a cooling product specially designed for cooling the communication cabinets and is suitable where the internal heating value of cabinet is large, the internal electronic equipment is sensitive to the ambient temperature, and the inside and outside shall be completely isolated. This product is fully functional and featured with high reliability, simple installation, performability after power-on, no complicated debugging, etc.

#### Working principle:

After the air conditioner is powered on, the low-pressure steam of refrigerant in the cooling system is sucked by the compressor and compressed into high-pressure steam and then discharged to the condenser. Meanwhile, the air sucked by the fan outside the cabinet flows through the condenser, taking away the heat released by the refrigerant and condensing the high-pressure refrigerant steam into high-pressure liquid. The high-pressure liquid through the throttle device is sprayed into the evaporator, and evaporates under the corresponding low pressure to absorb the surrounding heat. Meanwhile, the fan in the cabinet makes the air continuously exchange heat through the fins of evaporator, and delivers the cooled air after heat release to the cabinet. In this way, the air in the cabinet continuously circulates to reduce the temperature.

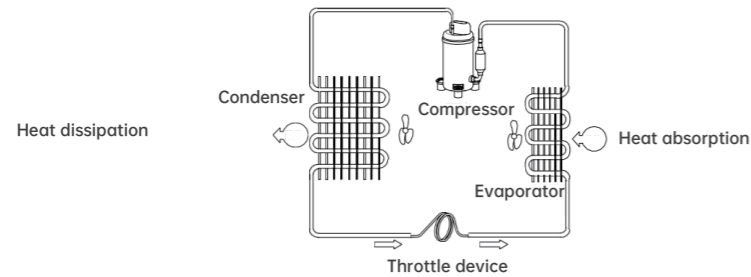

Fig. 3-4 Cooling Schematic of Air Conditioner

#### Functions

- Cooling:** The parameters of air conditioner can be set through the display screen or background software: cooling set temperature and cooling deviation temperature. When the temperature inside the cabinet is higher than the cooling set temperature + cooling deviation temperature, the cooling starts; when the temperature inside the cabinet is lower than the cooling set temperature, the cooling stops.
- Heating:** The parameters of air conditioner can be set: heating set temperature and heating deviation temperature. When the temperature inside the cabinet is lower than the heating set temperature, the heating starts; when the temperature inside the cabinet is higher than the heating set temperature + heating deviation temperature, the heating stops.
- Air supply:** The air conditioner can make the temperature uniform inside the cabinet through air supply so as to avoid local overheating. When the temperature inside the cabinet is lower than the start limit of cooling, the air supply function will be automatically turned on.
- Dehumidification:** When the humidity in the cabinet is greater than the start limit of dehumidification (default: 80%, range: 50% ~ 99%) and the temperature inside the cabinet is less than the start limit of dehumidification (default: 25 °C, range: 20 ~ 40 °C), turn on electric heating dehumidification; and turn off heating when the temperature inside the cabinet rises to the stop limit of dehumidification (default: 30 °C, range: 25 ~ 50 °C) or the humidity falls back to the stop limit of dehumidification (default: 75%, range: 50% ~ 99%).

### 3.8 Product dimensions

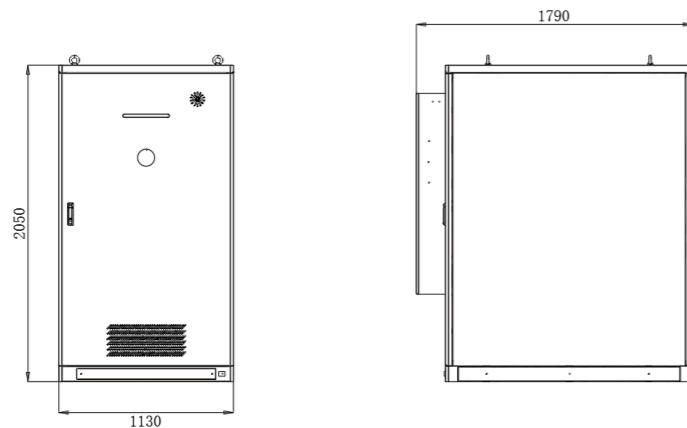

Fig.3-5 Product Dimension Drawing (mm)

## 4. Transportation and Installation

### 4.1 Receiving inspection

Please make the following inspections after receiving the product:

S/N	Items	Remarks
①	Check whether the outer package of product is intact and check it for any damage, soak, damp or deformation.	
②	When receiving goods from the transport company, be sure to carefully check the products against the supply list, and confirm that the ordered product options are complete. Any missing or damage of goods, when discovered, shall be reported to the transport company.	
③	Check whether the nameplate information is consistent with the ordered product model.	
④	Check the surface of product and accessories for any damage, scratch, depression and other defects.	
⑤	Check warning label for any damage, scratch, blur and other defects.	

Table 4-1 Receiving Inspections



Please open the package from outside to inside, and do not violently knock at or put down the package!

### 4.2 Storage

- Temperature shall remain between 30 °C and + 60 °C.
- Place the equipment in a clean and dry space against the water splashing, rain, humidity, high temperature or outdoor exposure.
- Ensure that the storage space is free of harmful gases, flammable and explosive products and corrosive chemicals.
- For the long-term storage, be sure to cover the module or take appropriate measures to prevent the module from the pollution and environmental influence.
- Avoid the mechanical impact, heavy pressure, strong electric field and strong magnetic field.
- Avoid the direct sunlight, keep a distance  $\geq 2m$  from heat source,  $\geq 50cm$  from wall, window or air inlet and jack up the packaging box  $\geq 20cm$  high from the ground .



- ◆ The products in storage for more than 3 months under the above conditions shall be recharged once.
- ◆ The products in storage for more than 6 months under the above conditions shall be tested for capacity.
- ◆ The products in storage for more than 1 year under the above conditions shall be re-inspected and can only be used after the pass judgment is made.

### 4.3 Carrying

Energy storage system can be carried with forklift and crane by the operators who have been trained and qualified.



- ◆ Please pack the product strictly before transporting it by truck, and select the closed box for long-distance transport.
- ◆ Do not transport this product together with equipment or articles that may affect or damage this product.

### 4.3.1 Carrying with forklift

Adjust the width and size of fork so that the center of gravity falls in the center of fork. Insert the fork at the position shown in the following figure.

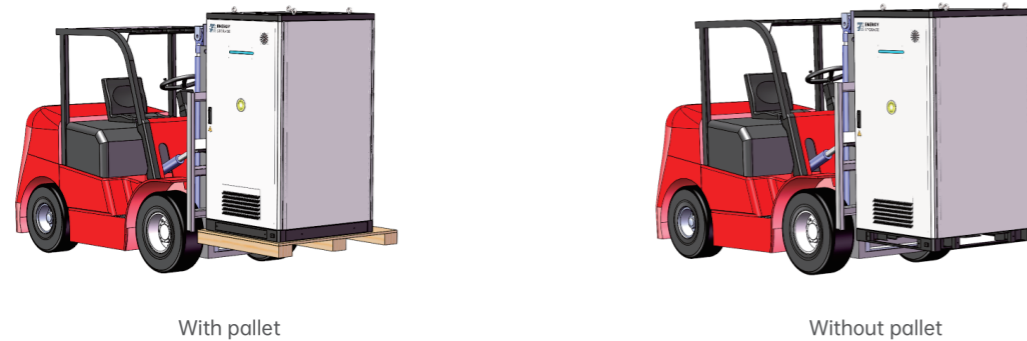

Fig.4-1 Schematic of Carrying with Forklift



- ◆ Test the fork and adjust it if necessary. Fork up the energy storage system after the adjustment and carry it to a suitable position.
- ◆ Handle the energy storage system at the inclination angle less than 10° and with the fluctuation height as low as possible.
- ◆ Do not carry the cabinet with hydraulic forklift for long distance or along the slope. Otherwise the hydraulic forklift may be damaged.
- ◆ Lift or lower the cabinet with care to avoid the impact or vibration. When the forklift descends, take care not to press the foot.
- ◆ Move the cabinet with someone around to support it, and level the ground.
- ◆ Considering that the equipment is high and may block the driver's line of sight, it is recommended to arrange personnel to guide the driver as appropriate.

### 4.3.2 Lifting

Flexible sling or strap with the bearing capacity greater than 3t shall be used, and the inclination of cabinet shall not exceed 10°. Tie the lifting lug of energy storage system tightly with a strap with the lifting hook at least 1m away from the top of cabinet, as shown in the following figure.

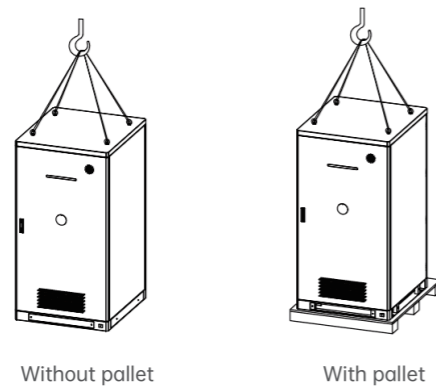

Fig.4-2 Lifting Schematic



- ◆ Carry out trial lifting to confirm that the strap can bear the weight of intelligent energy storage terminal and there is no inclination.
- ◆ Place the hook at the center of gravity.
- ◆ After the lifting, ensure that the swing angle is less than 10°.
- ◆ Before the carrying, be sure to confirm that the front door of cabinet is locked, so as to avoid sudden opening during carrying to cause injury.
- ◆ Lift or lower the cabinet with care to avoid the impact or vibration.
- ◆ When equipment is used for carrying, be sure to take the wooden pallets and place the module horizontally, and do not carry the equipment upside down or with edge on.
- ◆ Do not allow the lifting ropes to touch the modules during crane lifting

## 4.4 Installation of equipment

### 4.4.1 Safety tips

Ignoring the following safety tips during installation may lead to equipment damage, personal injury or serious casualties. Please strictly abide by the following safety tips.



- ◆ Installation shall be carried out correctly by professionals following all warning prompts.
- ◆ Before the installation, ensure that the mechanical strength of the mounting position is sufficient to support the weight of equipment. Otherwise the mechanical risk may be caused.
- ◆ Do not wear loose clothes or accessories when installing the product. Otherwise the electric shock may be caused!



- ◆ To facilitate installation and maintenance, please leave enough space around the equipment, such as the sufficient cooling air flow, necessary gaps, and space required by cables and cable support structures.
- ◆ Make sure that any spanning elements or mounting racks with components are properly grounded and that the connecting surfaces are not painted.
- ◆ Preferably use Nickel-plated copper, but aluminum can also be used.
- ◆ Before joining the aluminum bus bar, remove the oxide layer and apply a suitable anti-oxidation jointing mixture.

### 4.4.2 Environmental requirements of installation

Item	Environmental requirements
Site	<ul style="list-style-type: none"> <li>● Good ventilation;</li> <li>● Professional measures against rain, wind and dust at the air inlet and outlet;</li> <li>● No trees around the installation location to prevent the door or air inlet from blockage by the branches or leaves blown over by strong wind;</li> <li>● Necessary measures against fire, water and rat;</li> <li>● Away from areas where toxic and harmful gases are concentrated;</li> <li>● Away from flammable, explosive and corrosive materials;</li> </ul>
Foundation	<ul style="list-style-type: none"> <li>● Flat and dry installation surface, and no water accumulation on the ground;</li> <li>● Level ground without shake, bearing capacity more than the weight of intelligent energy storage terminal.</li> </ul>
Space	Enough space around the intelligent energy storage terminal for heat dissipation, maintenance and escape
Altitude	4,000m, derated if the altitude is more than 2,000m (non-standard treatment for high altitude models)
Temperature	-30 °C ~ + 60 °C; long-term operation at 110% overload below + 45 °C, and derated operation above + 50 °C
Relative humidity	0%-95%

Table 4-2 Environmental Requirements of Installation



- The invasion of moisture may easily lead to damage to the energy storage terminal! To ensure the normal operation of energy storage terminals:
- ◆ Do not open the cabinet door when the air humidity is 95%.
  - ◆ Try not to open the cabinet door for maintenance or overhaul in rainy or humid weather conditions.

#### 4.4.3 Site requirements of installation

##### Foundation

Energy storage system shall be installed on concrete or other non-combustible surfaces, and the installation plane shall be horizontal, firm and flat with sufficient bearing capacity. No depression or inclination is allowed.

The outgoing line of energy storage system shall be taken into account for the construction of foundation to reserve the trench or incoming hole. Please refer to the following figure for the mounting holes.

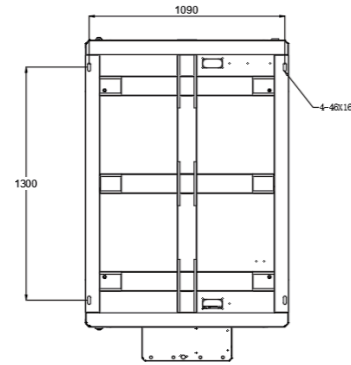

Fig. 4-3 Mounting Holes (mm)

##### Requirements for civil construction

- Concrete strength shall not be less than C20, 40cm underground, 20cm above-ground; the concrete size: 1988 \* 1300 \* 600mm; intact, smooth and crack-free; outline: 1130\*1790 mm. After the installation, four edges of equipment shall be 100mm away from those of foundation;
- The embedded pipes of foundation shall correspond to the opening positions of the bottom plate, so as to avoid the construction failure due to the non-correspondence between the pipes and openings;
- Stainless steel or hot dip galvanized  $\phi 12$  embedded parts or expansion bolts shall be used for fixation;
- Excavation and embedding are not allowed in the basement, and the foundation depends on the situation;
- The reserved size behind the cabinet for installation shall not be less than the width of cabinet body.
- The bearing capacity of base shall not be less than 3t.

The following foundation drawing is for reference only and shall not be used for the final construction. During construction, the bottom of equipment shall be higher than the highest water level in local history, and the equipment (including height, embedded part, threading pipe, etc.) shall be adjusted according to the technology and site. For installation on the hard ground, the equipment shall be bolted at the points depending on the actual situation. For installation in lawn and other places without hard ground, the foundation shall be constructed first. Equipment shall be preferably welded at the points depending on the actual situation.

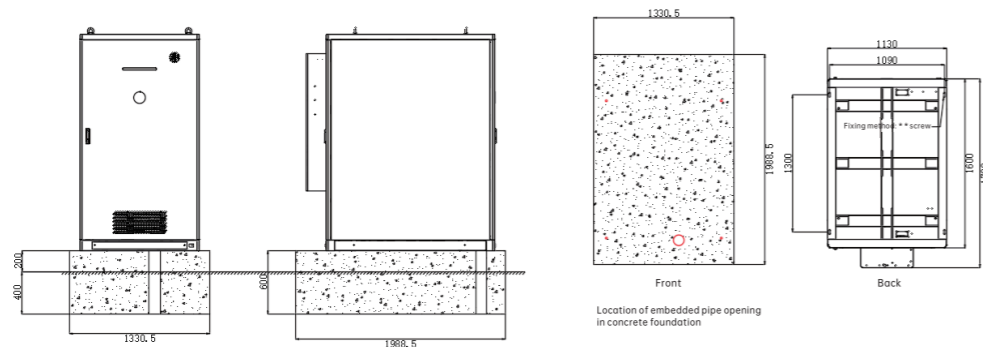

Fig. 4-4 Schematic of Civil Construction

#### Trench requirement

The incoming holes are set at the bottom not the side of energy storage system to prevent foreign matters. The incoming lines shall be arranged in the trench. Therefore, the trench shall be provided in the site. There are the following requirements for the trench:

- The incoming holes are set at the bottom of energy storage system, so the trench shall be provided with the necessary measures against the dust and rat to prevent any foreign matter.
- Necessary design against water and moisture is required for the trench to prevent cable aging and short circuit which may affect the normal operation of energy storage system.
- The cables with large cross-sectional area are preferable in the design of the trench due to the high power of energy storage system.

#### 4.4.4 Space requirements of installation

##### Installation of single energy storage system

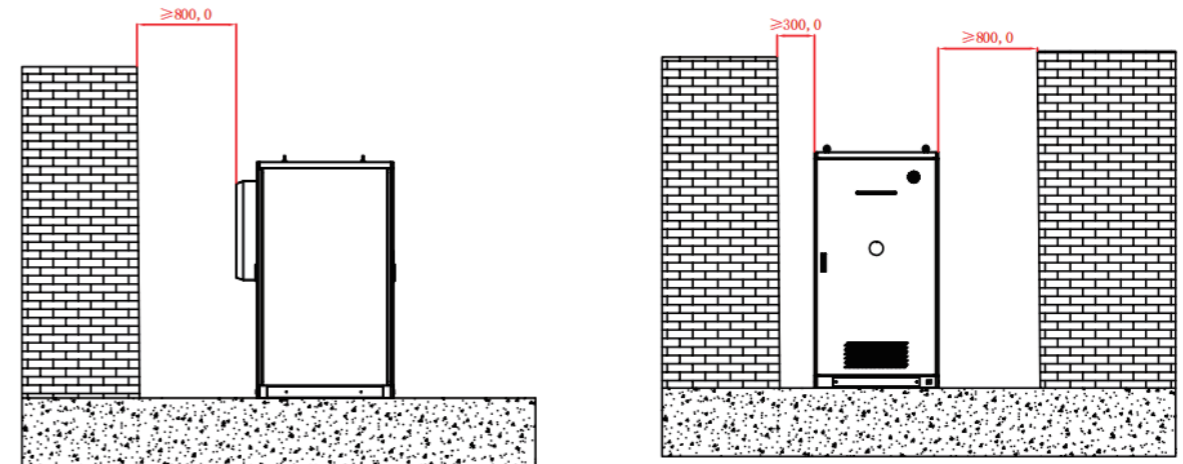

Fig. 4-5 Schematic of Mounting Space of Single Energy storage system (mm)

##### Installation of multiple energy storage systems

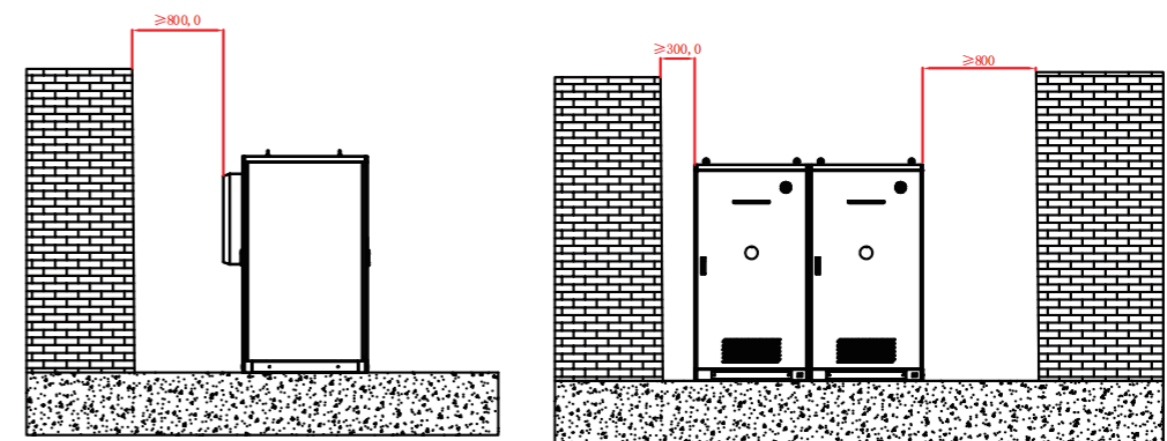

Fig. 4-6 Schematic of Mounting Space of Multiple Energy storage systems (mm)

#### 4.4.5 Installation equipment

##### Mounting tools

Recommended mounting tools include but are not limited to the following, and other auxiliary tools may be used as necessary on the actual basis.









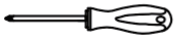
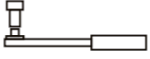

			
Clip-on ammeter	Multimeter	Screwdriver	spanner
			
Torque spanner	Electric drill	Crimping plier	Oblique plier
			
Insulating tape	Brush	Insulating gloves	Hydraulic plier

Table 4-3 Schematic Table of Mounting Tools

**CAUTION** Mounting tools shall be insulated to avoid the electric shock.

##### Installation steps

- Remove 4 M12 bolts connecting the pallet to the cabinet with a socket or spanner.
- Make sure that the fixing holes on the installation plane are consistent with the mounting holes at the bottom of cabinet. Please refer to Fig.8 for the positions of fixing holes;
- Carry the energy storage system to the mounting position.
- Align the screw holes and fix the equipment on the channel steel or foundation with 4 M12 bolts according to the mounting torque of 27N·m.
- The cabinet can also be welded on the metal floor of channel steel or prefabricated cabin and be sure to avoid the burn-in and take antirust measures.

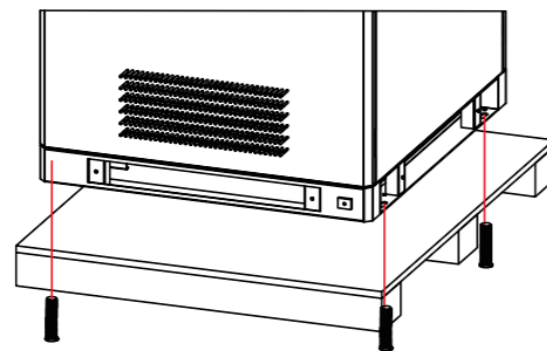

Fig.4-7 Schematic for Removing Pallet

#### Post-installation inspection

After the installation is complete, please check the items in the following table:

S/N	Item	Measures	Remarks
1	Intelligent energy storage terminal is installed at a preset fixed point as required and is not loose	In case of any looseness, please tighten the screw again	
2	Mounting space is as recommended in "4.4.4 Requirements for Mounting Space"	If the space is insufficient, preferably redesign the outer cabinet before the installation	

Table 4-4 Post-installation Checklist of Energy storage system

#### 4.5 Electrical installation

##### 4.5.1 Instructions of connection terminals

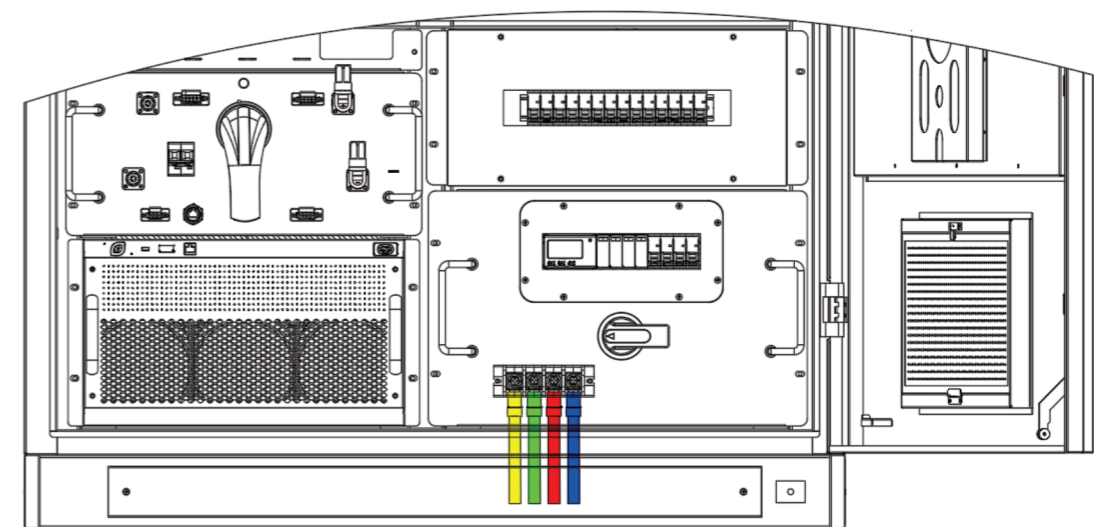

Fig. 4-8 Schematic of Connection Terminal

Phase A, Phase B, Phase C and Phase N corresponding to yellow, green, red and blue in the above figure are AC input and output power lines connected to the energy storage system by external power distribution box. 25mm<sup>2</sup> cable and DT-25 copper lug are recommended.

##### 4.5.2 Description of communication interface

Serial number	Communication interface	Interface description
1	Communication interface between control box and peripheral components	For commissioning by professional engineers

Table 4-5 Communication interface description table

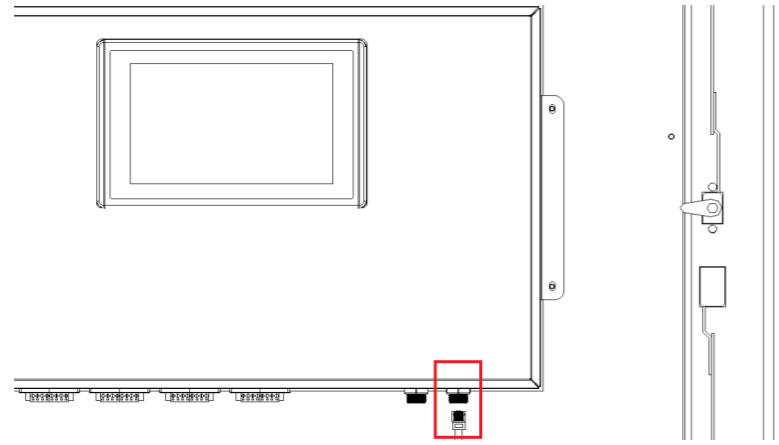



Fig. 4-9 Communication Interface Diagram

4.5.3 Safety precautions

During electrical operation, professionals shall wear protective equipment, such as helmets, insulated shoes and protective gloves. The following procedures shall be followed for the electrical installation:

-  The intelligent energy storage terminal shall be installed and operated by the professionals in strict accordance with User's Manual.
- Installers shall comply with the relevant electrical operation procedures of their countries or regions.
- Do not install the equipment in a live status. Otherwise the electric shock may be caused.
- Before the installation, all switches of the intelligent energy storage terminal and the external front stage shall be disconnected, and confirm that all cables and intelligent energy storage terminal are powered off 15min later.
- A warning sign shall be left at the disconnected position to prevent it from being re-powered on during installation.
- Necessary grounding or short-circuit connection is required.
- Live parts shall be treated as necessary and isolated with insulating materials to avoid the personnel injury.

4.5.4 Cable fabrication

1) Recommended terminal cables

Terminal	Maximum voltage	Maximum current	Terminal model	Recommended diameter
Phase A at AC side	450Vac	145A	DT-50	50mm <sup>2</sup>
Phase B at AC side	450Vac	145A	DT-50	50mm <sup>2</sup>
Phase C at AC side	450Vac	145A	DT-50	50mm <sup>2</sup>
Phase N at AC side	450Vac	145A	DT-50	50mm <sup>2</sup>
Grounding wire	\	\	DT-16	16mm <sup>2</sup>

Table 4-6 Recommended Terminal Cables

Description: The cable shall meet the requirements for voltage insulation level, and shall be protected properly to avoid the scratching and damage of the insulation skin.

2) Cable fabrication

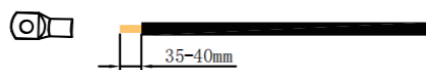

Fig. 4-10 Schematic of AC Cable Terminal

- ① Prepare three DT-25 and one DT-16 copper lugs and 50mm heat shrinkable pipes (Φ16mm) corresponding to four colors of yellow, green, red and blue;

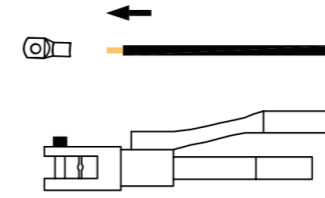

Fig. 4-11 Pressing Schematic of AC Cable

- ② Peel the cable for 35-40mm, penetrate it into DT-25/DT-16 copper lug, and press the exposed cable tightly with hydraulic plier;
- ③ Put on heat shrinkable pipes of corresponding colors, and wrap the cables with heat shrinkable pipes using the hot air gun or other heating devices;
- ④ Finished cables are as shown in the following figure;

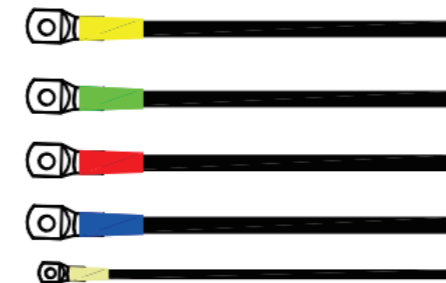

Fig. 4-12 Schematic of Pressed AC Cables

Note: The diagram is for reference only and the connector in kind shall prevail.

4.5.5 Cable connection

1) Pre-connection inspection

Be sure to complete the following inspections before the connection

S/N	Item	Description
1	The connecting cables have the corresponding diameter and shielding	
2	Equipment and products are well grounded	
3	Specified electro-static discharge (ESD) procedures are followed and antistatic wrist strap is worn	
4	Relevant options for connection are ready	

Table 4-7 Pre-connection Checklist

## 2) Grounding

Connect the grounding wire of energy storage system to any one of two grounding points at the lower right at front and the lower left at rear on actual basis (please refer to the following figure).

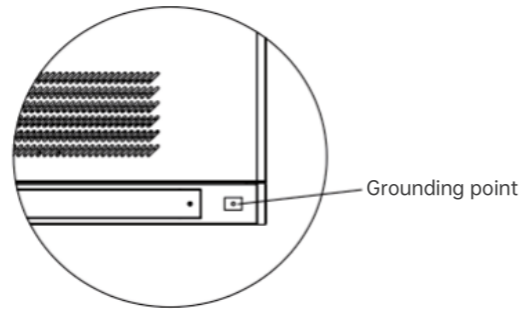

Fig. 4-13 Schematic of Grounding Point

## 3) Connection at AC side

- ◆ Before the connection, be sure to reconfirm that the AC circuit breaker is disconnected and the connected cable is not charged.
- ◆ Eliminate the grounding fault if any before the connection.
- ◆ Incorrect connection sequence may cause fire.
- ◆ The cables shall be tightened. Otherwise the fire may be caused.
- ◆ Wrong connection will cause the converter failure and the burn-out of equipment.

- ① Copper lug terminal is used for the cable at AC side of circuit breaker, and the interface at AC side is located on the front of distribution box in the cabinet;
- ② First remove the panel of distribution box, and connecting copper bars are A, B, C and N from left to right;
- ③ Identify the phase A, phase B, phase C and phase N of cable and mark them well;
- ④ Confirm the phase sequence of AC output terminal of energy storage system, match the cable identification with the phase sequence of terminal one by one, and fasten M6 screws to connect the terminal and copper bar of energy storage system according to the recommended torque of 10N·M.

## 4) Post-connection inspection

After the connection, the following items shall be inspected and measured again to avoid the equipment damage and property loss:

S/N	Item	Description
1	Switches at the battery side and grid side are disconnected before the measurement to ensure that the DC side and AC side of converter are not charged	
2	Positive and negative connection between battery and converter and AC phase sequence are correct and already fastened. Measure the resistance between three phases which shall be $M\Omega$ . If it is $k\Omega$ or less, check the circuit	
3	External control cable, grounding wire and communication cable are tightened	
4	Grounding wire resistance is less than $0.1\Omega$ , and the cable is intact and free of damage or crack	
5	Clean the installation area. There are no missing tools or foreign objects in the installation area	

Table 4-8 Post-connection Checklist

## 5. Debugging and Operation

### 5.1 Pre-operation inspection

Check the following items before operation:

S/N	Item	Description
1	Check the energy storage system and devices for condensation (water film or water droplet on the surface). If so, the air conditioner and cooling fan shall be powered and ventilated independently until the phenomenon disappears	
2	Measure whether the voltage on the incoming line side of the energy storage system is within the specified range, and confirm that there is no fault such as phase loss and short circuit	
3	Power input terminals (A, B, C, N) are connected correctly and securely	
4	Energy storage system is reliably grounded	
5	All control signal cables are connected correctly	
6	Distribution terminals are intact, undamaged and insulated	
7	There are no foreign bodies such as wire heads and metal chips that will cause short circuit of signal lines and power lines inside and outside the energy storage system	

Table 5-1 Pre-operation Checklist

### 5.2 Start steps

Start the energy storage system after the pass judgment is made:

- ① Close AC main circuit breaker Qf1;
- ② Close the front-end lightning protection circuit breaker Qf2;
- ③ Close AC main circuit breaker QF3 of secondary circuit that the distribution box is electrified;
- ④ Close air conditioner power supply circuit breaker QF5 that the indicator lamp of air conditioner panel on the rear door panel lights up;
- ⑤ Close lighting fan power supply circuit breaker QF4. When the front door is opened, the lamp lights up, adjust the temperature sensor knob of fan to make its trigger limit lower than the current temperature that the fan rotates (after confirming the rotation, adjust the temperature back to the original value. Fan will start at 30 °C by default);
- ⑥ Close UPS power supply input circuit breaker QF6. If the indicator lamp of UPS panel is not on, long press the Power button on UPS panel (about 3s) until a "beep" sound to enter the online mode.
- ⑦ Close UPS power supply output circuit breakers QF7 and QF8. The weak current box is powered on, 24V DC power supply in the cabinet is turned on, and the display and control module screen goes on.
- ⑧ Close the battery high-voltage box circuit breaker QF that the high-voltage box is powered on and the panel power indicator lamp goes on.

After start, parameters can be set remotely or locally.



Start the energy storage system strictly according to the above steps. Otherwise the energy storage system may be damaged or fail.



### 5.3 Stop steps

#### 5.3.1 Normal stop

Display and control module EMU issues a “Stop” instruction, and the energy storage system stops running and automatically disconnects the internal AC and DC circuits.



Disconnect switch is be attached with warning sign to avoid others powering on by mistake.

#### 5.3.2 Emergency stop

In case of emergency, press the red emergency stop button on the front cabinet door that the converter stops and the power circuit breaker QF1 in the energy storage system automatically disconnects.

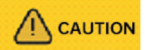

- ◆ After disconnecting all input power supplies of energy storage system, be sure to open the door to check the energy storage system 35min later.
- ◆ Confirm that the energy storage system is powered off before opening the cabinet door.
- ◆ Normally, please stop the energy storage system according to normal procedures. In case of emergency, the emergency stop procedures shall be followed to ensure the quick response and protect the personnel, energy storage system and peripheral equipment.

### 5.4 Recommend charging method

The recommended charging methods for Rechargeable Lithium Ion Cell, Rechargeable Li-ion Battery and LFP Lithium Ion Energy Storage System are listed in the table below:

	Cell	Module	Battery system
Charging method	Charge at constant current 201A until the voltage reaches 3.6V, then switch to constant voltage 3.6V till charge current drops to 15A	Charge at constant current 150A until the voltage reaches 85.5V, then switch to constant voltage 85.5V till charge current drops to 15A	Charge at constant current 150A until the voltage reaches 855V, then switch to constant voltage 855V till charge current drops to 15A

Table 5-2 List of charging methods

### 5.5 Lighting Board Mode

S/N	Lighting Board Mode	Lighting Board Expression
1	Warning Mode	Bright light yellow and alternating yellow
2	Protection Mode	Brilliant light red and alternating red
3	Normal Mode	Bright green
4	Charging mode	Green Positive Fill
5	Discharge mode	Green reverse reduction

Table 5-3 Lighting Board Mode List

## 6.Interface Operation Instructions

### 6.1 Main interface

After successful startup, you will enter the system main interface. In the main interface, you can query the status of the energy storage system, the topology diagram of the stacking system, the power curve, alarm information and other functions.

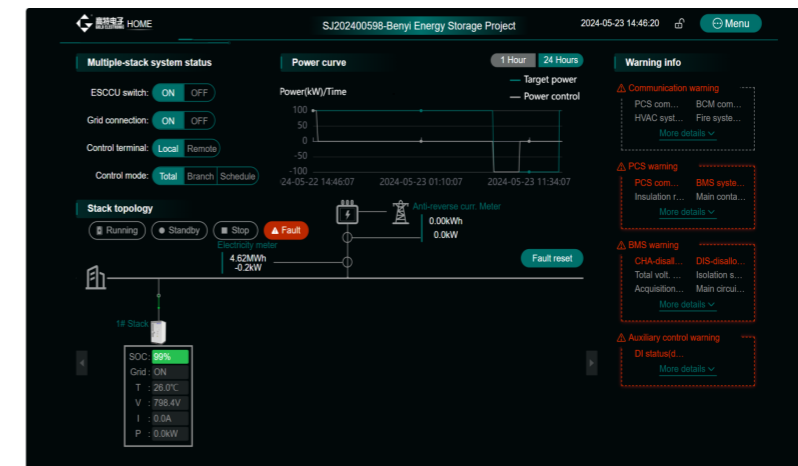

Fig.6-1-1 System Main Interface

#### 6.1.1 Energy storage system status

- ◆ Collector switch: Switching of the energy storage system on and off.
- ◆ Grid-tied or off-grid status: Switching between grid-connected and off-grid modes.
- ◆ Control source: Remote control and local control command switching.
- ◆ Control mode: Manual and automatic power control mode switching. The auto mode is scheduled auto mode, and the PCS power control is set according to Energy Management -> 24-hour schedule as in Figure 6-1-2. There are a total of 2 types of Manual Mode: Total Power Mode as in Figure 6-1-3 and Subsystem Mode as in Figure 6-1-4 to set up.

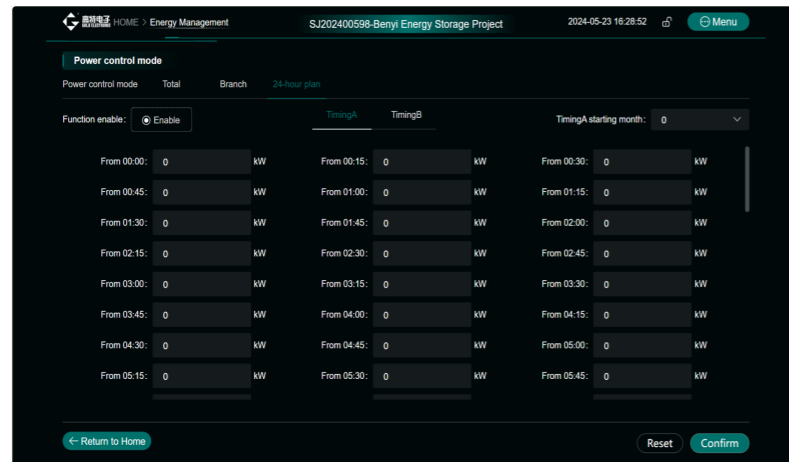

Fig.6-1-2 The 24-hour schedule

The 24-hour schedule is divided into 24-hour power settings for Daylight Saving A and Daylight Saving B. The Daylight Saving A start month and Daylight Saving B start month are set.

The 24-hour schedule is used for PCS active power control settings when the system is scheduled for automatic mode. Active power is a signed integer, positive numbers are discharged, negative numbers are charged. For example, if the starting month of seasonal A is March and the starting month of seasonal B is September, then the 24-hour power from March to August will be output according to seasonal A, and the 24-hour power from August to February will be output according to seasonal B.

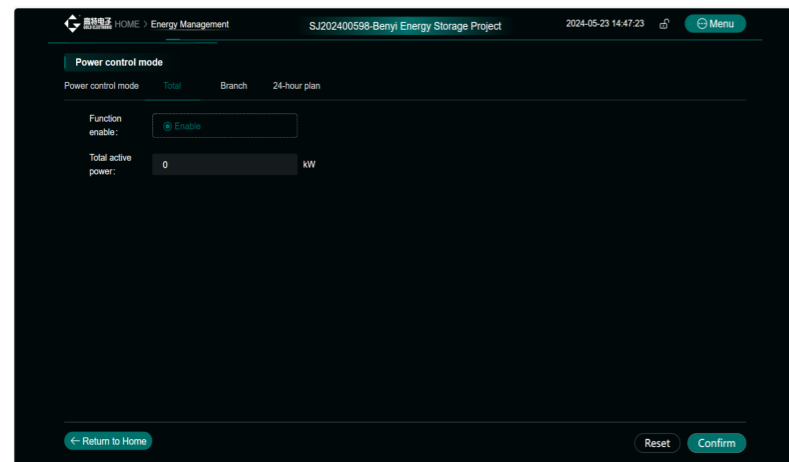

Fig.6-1-3 Total model

Total model, you can set the start and stop of the function enable and the total active power value, carry out the system average distribution PCS power control, press OK to start the total power mode control.

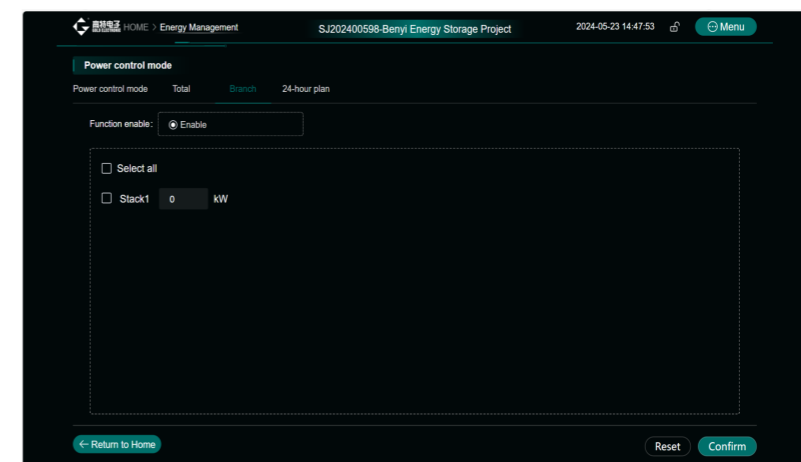

Fig.6-1-4 Branch model

Branch model, you can set the function enable start and stop, select all or set the active power of each stack individually, press OK for the selected sub-system to carry out sub-system mode control.

### 6.1.2 Topology of a stacked system (computing)

- ◆ Anti-reverse current meter, displaying the current active power, click on it to display the details as shown in Figure 6-1-5.

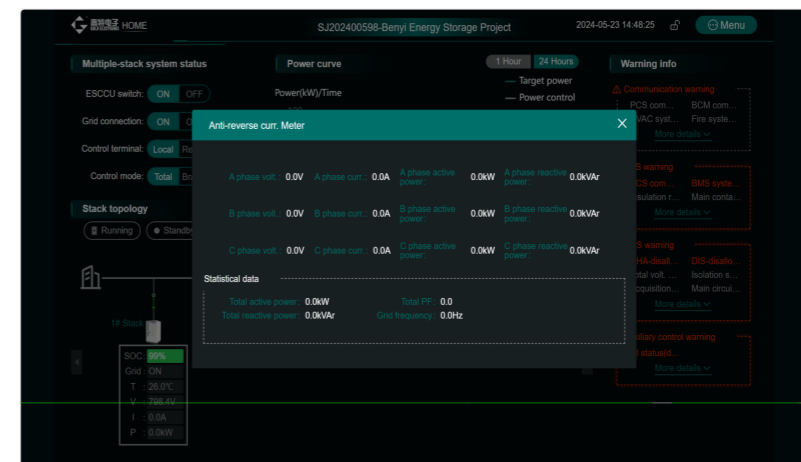

Fig.6-1-5 Anti-reverse current meter details

◆ Metering meter, displaying the current active power and current total active power, click on it to display the details as Figure 6-1-6.



Fig.6-1-6 Metering meter details

- ◆ System total active power  
Accumulated value of all PCS active powers.
- ◆ Relay status of the subsystem  
Unable to read relay status; currently judged according to PCS operating status.
- ◆ SOC readout of subsystem  
SOC value of BMS.
- ◆ Subsystem on-grid and off-grid status  
Read the on-grid and off-grid status of the PCS.
- ◆ Subsystem temperature  
Read the temperature value read by the thermometer and humidity meter
- ◆ Subsystem voltage  
Read the DC voltage of PCS
- ◆ Subsystem current  
Read the DC current of PCS
- ◆ Subsystem active power  
Read the active power of PCS

### 6.1.3 Power curve

Graphs of total power and control control are realised and the data are presented in two time periods: 1 hour and 24 hours.

### 6.1.4 Warning info

#### ◆ Communication warning

If any of the PCS, BMS, fire protection, or air conditioning equipment in the system suffers communication disconnection, a red alarm will be displayed, click to enter the detailed information display.

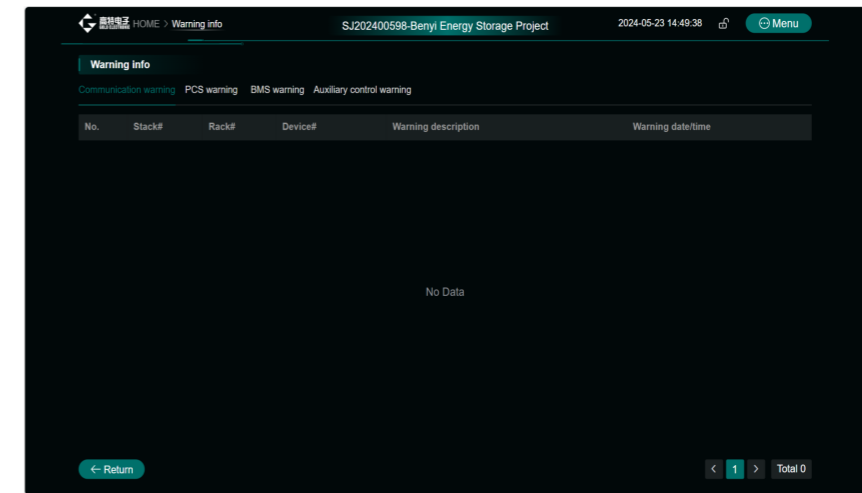

#### ◆ PCS warning

Refer to the PCS alarm details of the system. Click on PCS Alerts, you can enter the detail interface of PCS alarm.

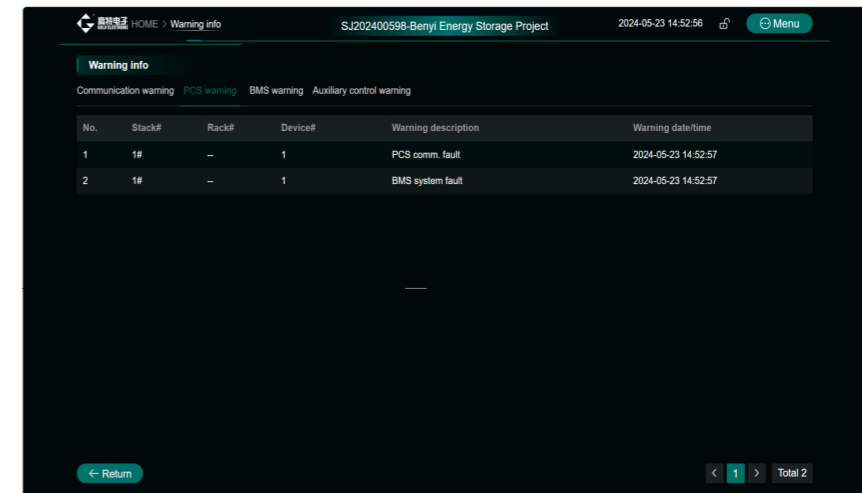

◆ BMS warning

Refer to the BMS alarm details of the system. Click on BMS Alerts, you can enter the detail interface of BMS alarm.

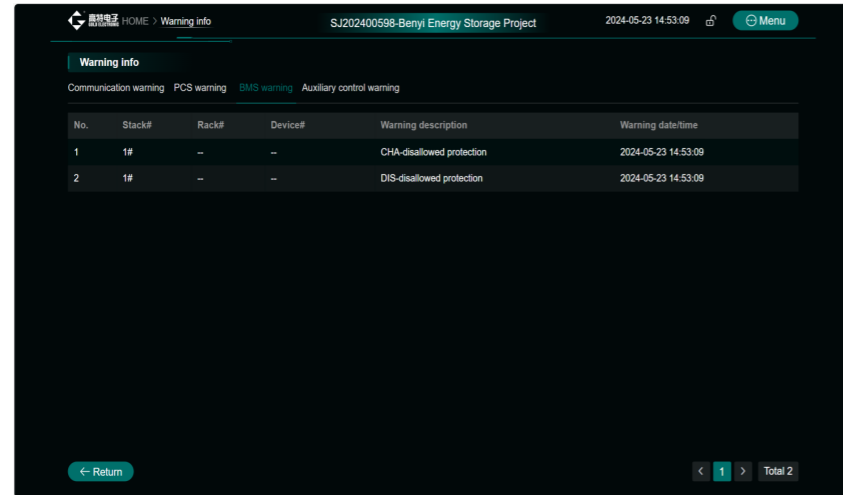
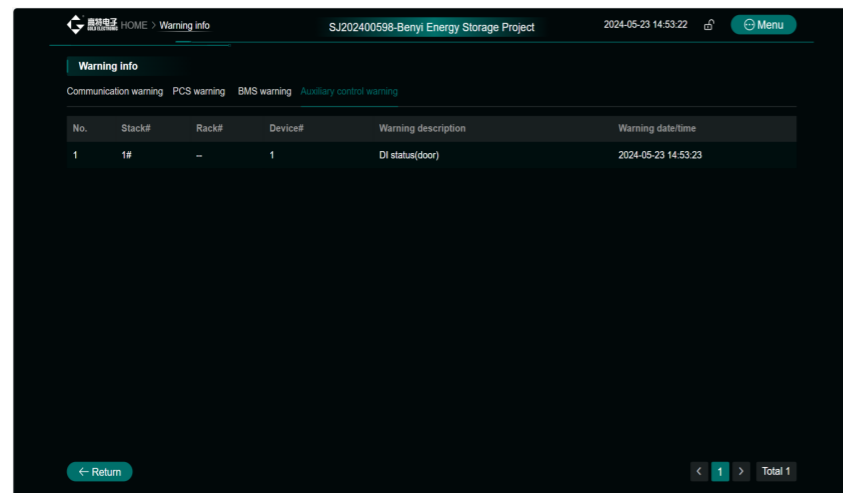

Fig.6-2-1 Subsystem details screen

Subsystem details interface shows the real-time information of the cluster of the heap, mainly cluster real-time information status, cluster information, cluster power information, cluster extreme value information, cluster system topology map, alarm information.

◆ Auxiliary control warning

Refer to the alarm information collected by the fire protection, circuit breaker, fan, PCS dry contact, DI collection, etc. in the system. Click any item, you can enter the detail interface.



◆ Cluster real-time information status:

There are 4 states of charging, discharging, standby and fault.

◆ Cluster information:

- Cluster Voltage
- Cluster Current
- Cluster SOC
- Cluster SOH
- Positive and negative insulation resistance

◆ Cluster power information:

- Rechargeable power
- Discharge Capacity
- Single Charge
- Single discharge power
- Daily Charge
- Daily Discharge Capacity
- Accumulated Charging Capacity
- Cumulative Discharge Power

6.2 Subsystem cabinet details interface

From the topology diagram of the heap system in the main interface, click on the cell block diagram of Heap X-Cluster X to enter the corresponding Heap X-Cluster X real-time information detail interface, see Figure 6-2-1 for details.

◆ Cluster extreme value information:

- Maximum Voltage and Maximum Voltage Serial Number
- Minimum voltage and minimum voltage serial number
- Maximum temperature and maximum temperature serial number
- Minimum Temperature and Minimum Temperature Serial Numbers
- Maximum SOC and maximum SOC serial number
- Minimum SOC and minimum SOC serial number
- Maximum SOH and maximum SOH serial numbers
- Minimum SOH and minimum SOH serial numbers

◆ Topology Diagram:

- Main switch: for the cabinet's circuit breaker status
- Main positive contactor
- Main negative contactor
- Group end voltage
- Group current
- Group power
- Group SOC
- Group SOH

◆ Alarm message:

Communication Status Alarm: The cabinet PCS, BMS, fire fighting and air conditioning equipment has communication disconnection, showing red alarm, click Communication Status Alarm to enter the communication status alarm detail display.

Cluster Alarm: The details of the alarm information of the cluster, click Cluster Alarm to enter the detailed display of Cluster Alarm.

Individual Alarms: Alarm information details of the individual battery, click Individual Alarms to enter the Individual alarm details display.

6.3 Parameter Settings

All parameters of the parameter configuration are power-down holding parameters and only need to be set once.

◆ Communication port

This device has 3 NICs, eth0 is used for 4G module communication and eth1 and eth2 are used for external general purpose, network parameter settings are detailed in Figure 6-3-1.

◆ System Parameters

Parameters can be set for heap parameter, cluster parameter and single cell parameter; see Fig. 6-3-2 and 6-3-3 for details of single cell parameter setting.

◆ Auxiliary control

Parameters can be configured and set for auxiliary control equipment.

◆ Project Parameters

See Figure 6-3-4 for details of the Project Parameters page; you can make parameter configuration settings for project configuration, local DIDO, and serial link sharing.

◆ Cloud Service setting:

After selecting Enable in the IOT Enable function, you can configure the parameters of the cloud service platform.

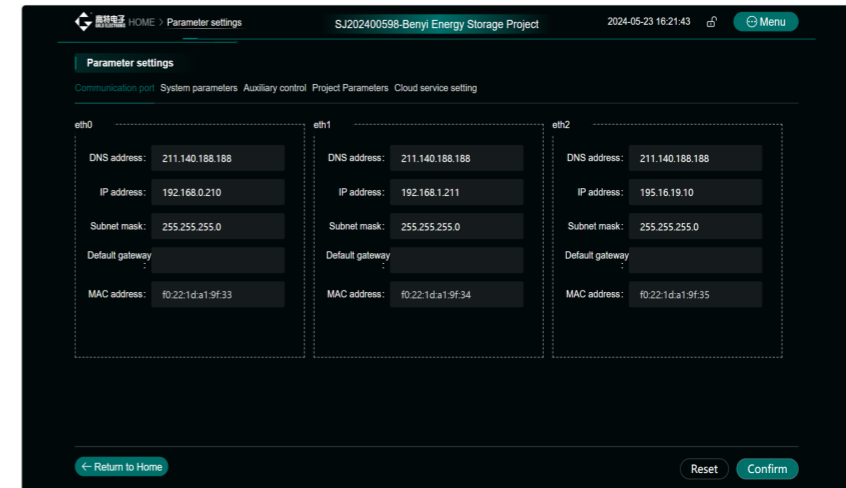

Fig.6-3-1 Communication port setting

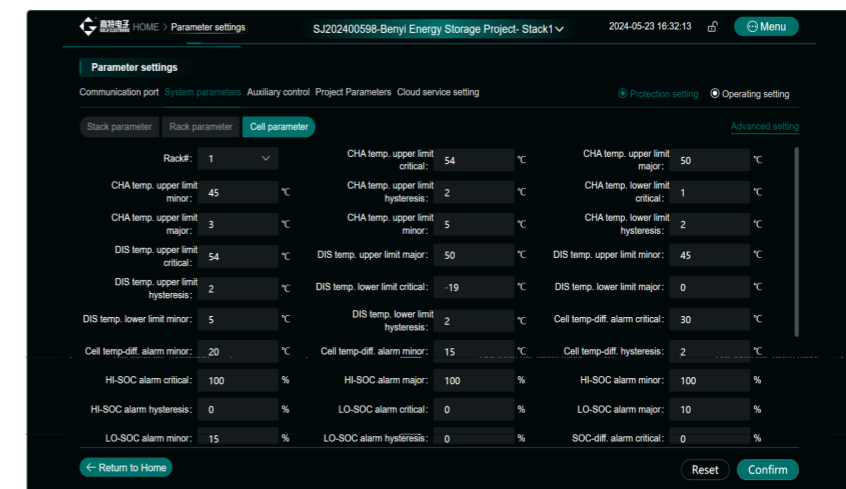

Fig.6-3-2 Single cell parameter setting (1)

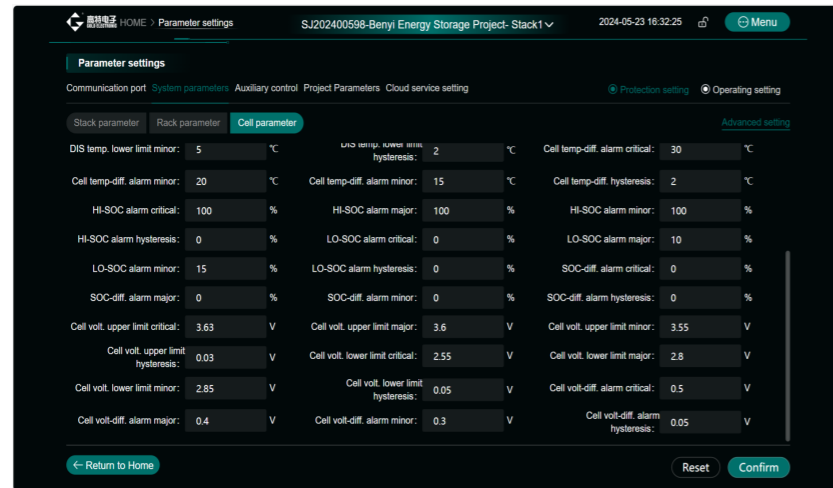

Fig.6-3-3 Single cell parameter setting (2)

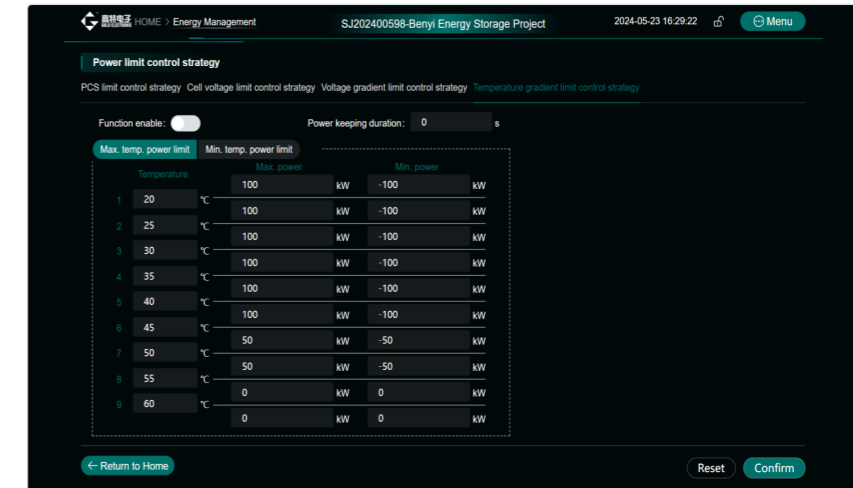

Fig. 6-4-1 Temperature gradient limit control strategy

#### 6.4.2 Voltage gradient limit control strategy

Single-unit voltage limiting power function enable on, voltage limiting power control; 10 single-unit voltage point control, respectively set the maximum discharge power (discharge power power control) and the maximum charging power (charging power power control).

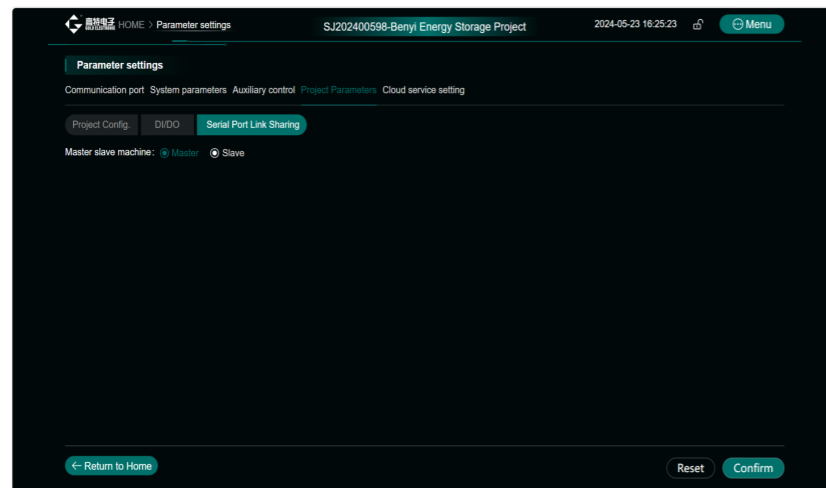

Fig.6-3-4 Project Parameters

### 6.4 Energy management settings

#### 6.4.1 Temperature gradient limit control strategy

Temperature-limited power function enable on for temperature-limited power control; 10 temperature point control, maximum power (discharge power power control) and minimum power (charge power power control).

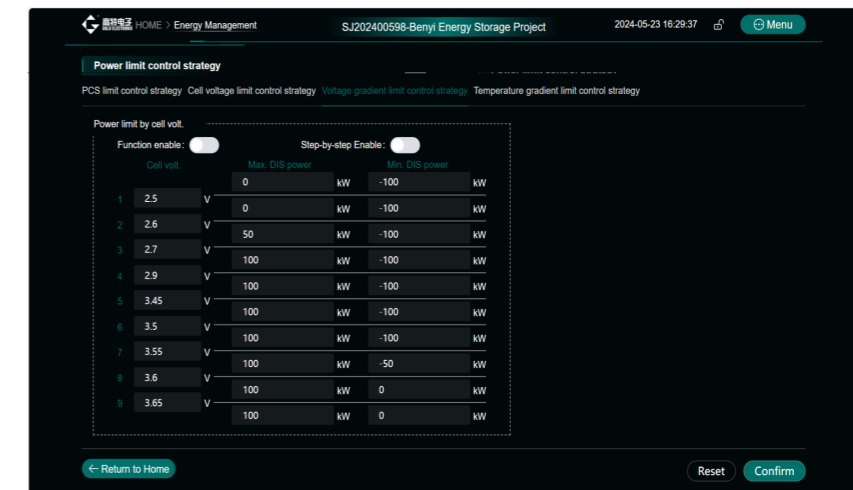

Fig.6-4-2 Voltage gradient limit control strategy

### 6.4.3 Cell voltage limit control strategy

The monomer voltage limiting function is enabled on for limiting monomer voltage setting; the main parameters are:

1. Upper limit value of single unit voltage (parking)
2. stop charging duration
3. stop charging single-unit voltage return value
4. lower limit value of single-unit voltage (parking)
5. Duration of stopping and discharging
6. Voltage return value of single unit when stopping and discharging

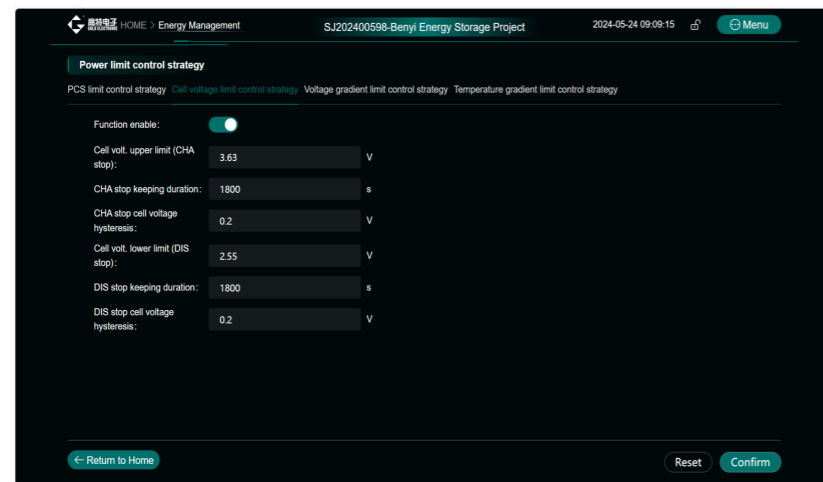

Fig.6-4-3 Cell voltage limit control strategy

### 6.4.4 PCS limit control strategy

The PCS power limiting function is enabled on for PCS power limiting control; the main parameters are:

1. PCS power upper limit value
2. PCS power lower limit value

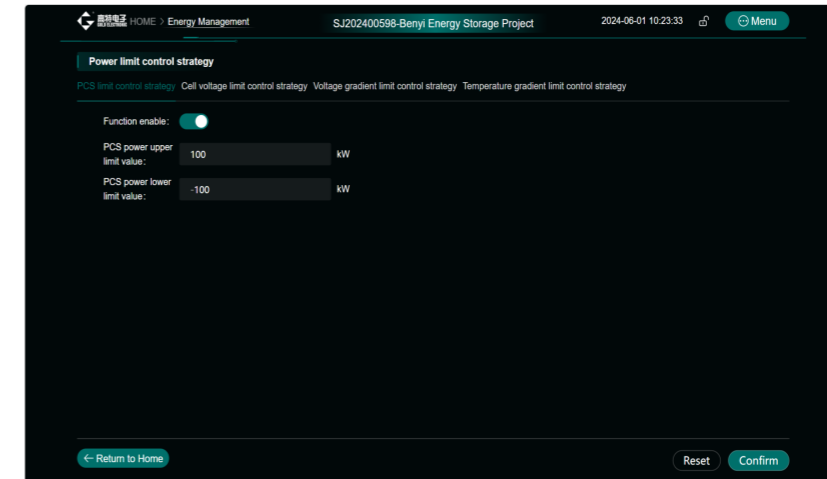

Fig.6-4-4 PCS limit control strategy

### 6.4.5 Static demand control setting

The demand limit setting function is enabled for demand limit power control; the main parameters are:

1. power return value
2. Adjustment time step
3. 12-month demand limit value setting, according to the month to set the demand limit power value.

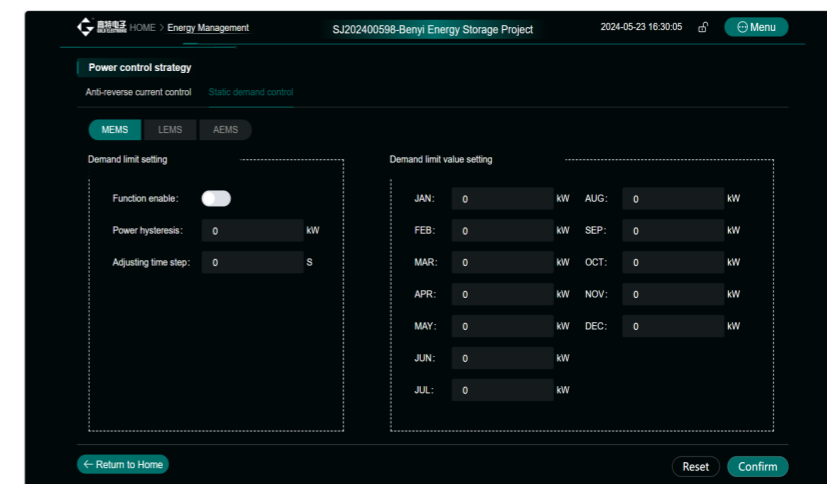

Fig.6-4-5 Static demand control setting

### 6.4.6 Anti-reverse current control setting

The anti-reverse current control function is enabled on for anti-reverse current limiting power control; the main parameters are:

1. Critical value
2. Power return value
3. Adjustment time step

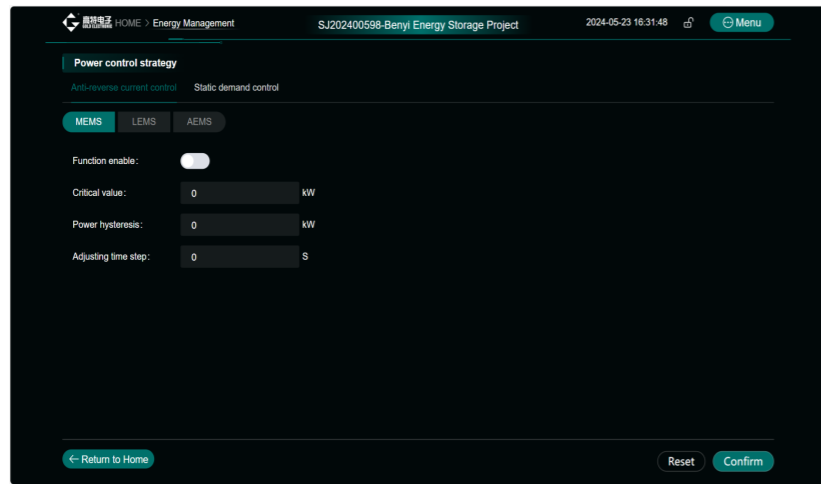

Fig.6-4-6 Anti-reverse current control setting

### 6.5 Air-conditioning equipment

Click Home→Heap Information→Real-time Information→Auxiliary Control Information→Air-conditioning Equipment; you can enter the information detail interface of air-conditioning equipment, see Figure 6-5-1 for details; the information detail page of air-conditioning equipment shows the real-time information of air-conditioning equipment, which is mainly telemetry information, telemetry status, telemetry alarm, remote control information, and remote adjustment information.

The following parameters can be set:

◆ Remote Control Information:

- Switching on and off: switching on and off can be performed
- Air conditioning cooling command: can be switched on and off
- Air conditioning air supply command: switchable between on and off
- Air conditioning standby command: switch between on and off
- Air conditioning heating command: switchable between on and off

◆ Remote control information:

- Cooling set point
- Cooling deviation
- High temperature alarm value
- Low temperature alarm value
- Heating setpoint

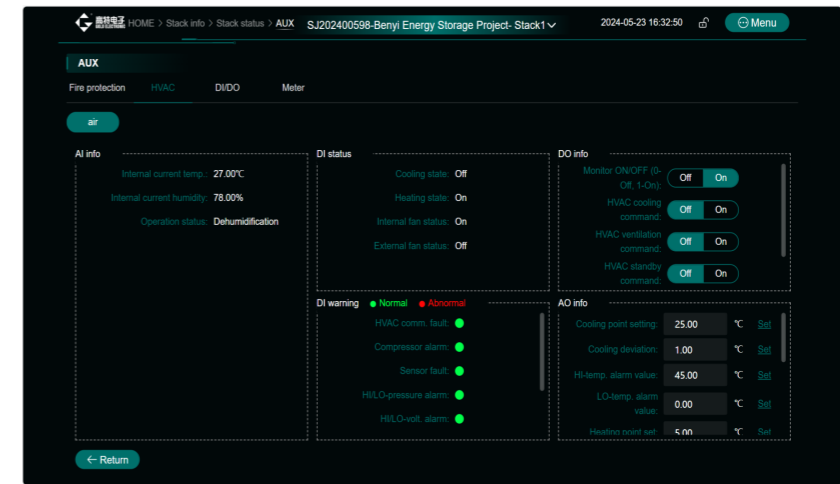

Fig.6-5-1 Air-conditioning equipment

### 6.6 Device settings

#### 6.6.1 ESMU setting

◆ Language Selection

Enables language switching between Chinese and English.

◆ Implement reboot management

In the reboot settings check the local hardware power failure reboot, click OK, please unplug the power to reboot.

Select software system reboot in reboot settings, click OK, software reboot, please wait patiently for reboot into the system main interface.



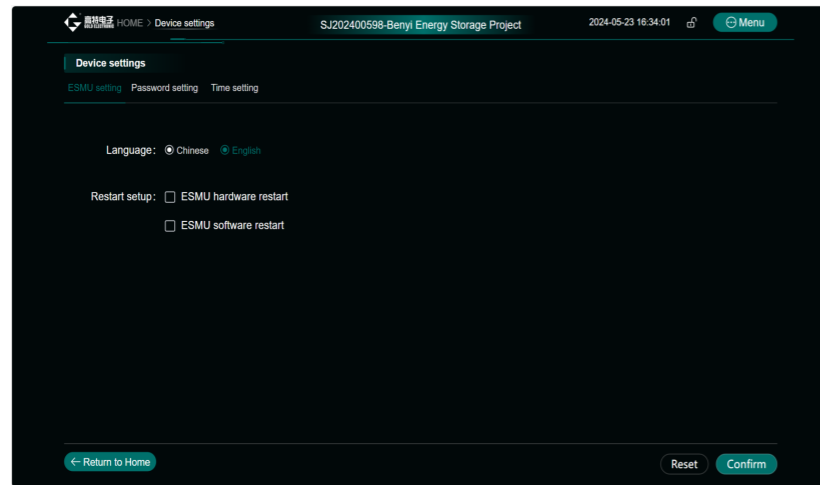

Fig.6-6-1 ESMU setting

### 6.6.2 Password setting

You can change the password.

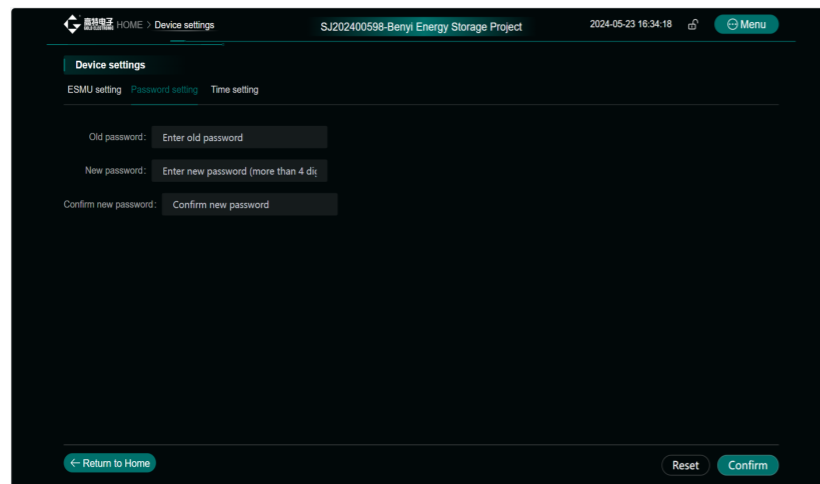

Fig.6-6-2 Password setting

### 6.6.3 Time setting

◆ Time setting: year, month, day, hour and second setting, see Figure 6-6-3 for time setting details.

◆ NTP Settings: See Figure 6-6-3 for details.

NTP Service IP (1): 84.16.73.33  
 NTP Service IP (2): 162.159.200.1  
 NTP service IP (3): 139.199.215.251  
 NTP pair time interval: 5000

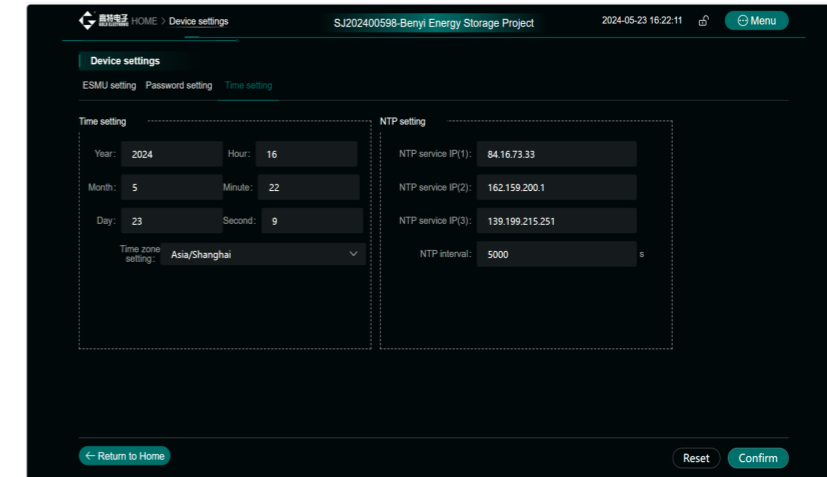

Fig.6-6-3 Time setting

### 6.6.4 History logging

1. implementation of historical operation logging, to be upgraded.
2. history alarm record query, to be upgraded.

### 6.6.5 About System

About the system version number, device serial number, service code, ICCID, service hotline, all rights reserved, local operation status information, ESBCM version information and other records.



Fig.6-7-1 About System

## 7. Troubleshooting

- ◆ Heap shutdown process: If the trigger is successful, the BMS will be shut down first, and then the PCS.
- ◆ Air conditioner shutdown process: The air conditioner shall be shut down in the following three situations: fire alarm, flooding, and emergency stop. After recovery from a fault, the Energy storage integrated control unit ES-CCU will restart the air conditioner.
- ◆ Reset function: When a fault occurs, reset by local manual command or remote command, clear the fault and restore the normal working process of the energy storage integrated control unit ES-CCU.

### 7.1 Fault Diagnosis Table

Alarm	Fault	Treatment
System-level major fault	Fire warning level>0	Turn off the BCM, PCS, air conditioners at all heaps
	Press down the emergency stop button	
Heap-level major fault	Flooding	Turn off the BCM, PCS, and air conditioner of that heap
Heap-level general fault		
Communication	ESMU and BCM communication failure	Turn off the BCM and PCS at the heap
	Air conditioning communication alarm	
	Temperature and humidity communication alarm	
	Fire communication alarm	
	IO communication alarm	
	PCS communication failure	
PCS	None	
BCM	Fuse abnormality	Turn off the BCM and PCS at the heap
	BCM internal CAN communication fault	
	The total voltage sampling is abnormal.	
	The charging cell is severely over-temperature.	
	The discharging cell is severely over-temperature.	
	The battery pole is severely over-temperature	
	BMU sampling circuit is abnormal	
	Temperature sampling line is broken.	
	The main circuit is not connected.	
BCM	None	
Air conditioner	Air conditioning failure	
Fire fighting	Gas alarm	Turn off the BCM and PCS at the heap
	Temperature sensor 1 alarm	
	Temperature sensor 2 alarm	

Alarm	Fault	Treatment
Fire fighting	CO sensor alarm	Turn off the BCM and PCS at the heap
	Fire extinguisher alarm	
	Fire alarm	



## 7.2 Frequently asked questions

1. Q: What is the problem if data flickering occurs when multiple subsystem cabinets are connected to the main control panel?

A: There may be a problem of duplication of modbus address or CAN address. Check whether the slave address of the connected device is correct.

A: 1) Click PCS fault information on the control interface, where the detailed cause of the fault is displayed.

2) Check the current power of the countercurrent meter to see whether the demand value is met in the charging state (this may be because the user occupies too much power, resulting in all the demand being allocated to the user).

Check whether the power of the countercurrent meter is 0 in discharging state. If yes, that means the PCS discharge power and user consumption are in balance.

2. Q: The control power setting is normal, and no fault alarm is displayed on the interface, but the BCM cannot be turned on and the PCS fault light flashes. What is the problem?

A: Click the PCS fault in the control interface, and detailed cause of the fault will be displayed.

3. Q: The PCS fault information on the interface shows that BMS allows upper/lower power limit faults, but the fault cannot be troubleshooted and resolved. What is the problem?

A: Check the current SOC value of BCM through the interface. If the SOC value is 0% or 100%, the problem is caused by emptying or fully charging. You only need to modify the positive and negative values of the lower power and the problem can be solved.

4.Q: The PCS fault information on the interface shows that there is a PCS power upper/lower limit fault, but it cannot be troubleshooted and resolved.

A: This is because the PCS power limit input is set to 0 on the interface. Check whether the power limit value set on the interface is 0.

5.Q: The PCS fault information on the interface shows that a temperature limit power upper/lower limit fault exists, but it cannot be troubleshooted and resolved.

A: Check the temperature power limit in the parameter setting interface to see if the error message still appears after the item is disabled. Check if the temperature power limit is set as 0.

6. Q: The PCS fault information on the interface shows a voltage limit power upper/lower limit fault exists, but it cannot be troubleshooted and resolved?

A: Check the voltage limit power in the parameter setting interface to see if the error message still appears after the item is disabled. Check whether the voltage limit power is set as 0.

7.Q: The PCS fault information on the interface shows that a battery emptying fault/battery full charge fault exists, but it cannot be troubleshooted and resolved.

A: Check the current SOC value of BCM on the interface. If the SOC value is 0% or 100%, the problem is caused by emptying or full charge. You only need to modify the positive and negative values of the lower power. When this problem occurs, the battery voltage will have a difference value. The battery needs to be charged to a value greater than the total of lower limit voltage plus the difference value before it can continue to discharge.



## 8.Regular Maintenance

The aging of devices inside the energy storage system cabinet due to the factors such as the ambient temperature, humidity, dust and vibration may lead to potential failures of energy storage system cabinet or reduce its service life. Therefore, daily and regular maintenance shall be made for the energy storage system cabinet.

### 8.1 Precautions before maintenance



- ◆ Please do not open the door of outdoor cabinet for maintenance in rainy, humid or windy weather. Otherwise,our company disclaims any responsibility for the resulting losses.
- ◆ In order to reduce the risk of electric shock, do not perform any other maintenance and overhaul operations beyond this manual. If necessary, contact our after-sales technicians for maintenance and overhaul.



- ◆ Energy storage system cabinet can only be maintained by the qualified professionals.
- ◆ Necessary safety precautions shall be taken before maintenance due to the strong electricity in the cabinet.
- ◆ Be sure to disconnect the high and low voltages on the power supply and battery side before maintenance.
- ◆ Please follow the correct operation procedures during maintenance.
- ◆ Due to the presence of an energy storage capacitor inside the energy storage system cabinet, please wait for more than 30min after power-off until confirm that the interior has no power, and then conduct the maintenance.
- ◆ After the power supply is disconnected, a warning sign shall be hung at the disconnection place to prevent someone from powering on during maintenance.
- ◆ In order to avoid accidental danger, maintenance personnel shall wear insulating protective equipment during maintenance.
- ◆ After maintenance, please clean the tools and materials in time, and check whether there are metal objects left inside or on the top of equipment.

### 8.2 List of maintenance items and cycles

#### 8.2.1 Daily routing inspection and maintenance items

##### Appearance

- 1) Check the surface of energy storage system for any obvious scratch, damage or deformation;
- 2) Detect the internal temperature of equipment with temperature measuring instrument and ensure no anomaly;
- 3) Check whether the components in the cabinet are firmly connected without looseness or disengagement;
- 4) Check whether the cabinet door can be unlocked flexibly;
- 5) Check the inside of outdoor cabinet for any oxidation or corrosion.

##### Electrical equipment

- 1) Check the cables, terminals and connecting wires in the cabinet for any damage, heat emission or peculiar smell;
- 2) Check the running status of equipment and the working status of electrical components such as circuit breakers, contactors and relays to ensure their normal operation;
- 3) Check the grounding system of energy storage system to ensure the reliable grounding and conforming resistance;
- 4) Monitor the voltage, current, temperature and other parameters of battery group to judge whether the battery is normal.



---

### Environment

---

- 1) Check whether the temperature and humidity in the energy storage system are within the appropriate range;
- 2) Check the inside of outdoor cabinet for any water seepage;
- 3) Check the ventilation system to ensure the good heat dissipation and no blockage or damage;
- 4) Check the air conditioner, dehumidifier and other environmental control equipment to ensure their normal operation.

---

### Safety protection facilities

---

- 1) Check whether the safety protection measures of the energy storage system, such as fence and warning signs, are intact;
- 2) Check whether the fire fighting equipment is complete and conforming;
- 3) Check the surroundings of energy storage system to ensure that no flammable and explosive materials are stored.

### 8.2.2 Semiannual maintenance items

Semiannual maintenance is the shutdown maintenance, and operation can only be carried out after shutdown for half an hour.

---

### Safety functions

---

- 1) Check the function of emergency stop button;
- 2) Simulated stop;
- 3) Check the warning signs of the body and other equipment signs. Please replace the blurred or damaged ones in time.

---

### Devices

---

- 1) Ensure the normal mechanical operation of contactors (auxiliary switches and microswitches);
- 2) Clean the ventilation and dust-proof screen regularly. Otherwise the cooling failure of module may result in overheating and even the fault;
- 3) Check the fan if any for any damage, abnormal noise, etc., and replace it in time if necessary;
- 4) Regularly collect the energy manager data to prevent the coverage caused by excessive data;
- 5) Check the inside of energy storage system for any loose or disengaged screw;
- 6) Check whether lightning protection equipment and fuses are tightened well.

---

### Wiring

---

- 1) Check whether the cables are arranged according to specification and for any short circuit. Please correct any anomaly immediately;
  - 2) Check whether all incoming and outgoing holes of outdoor cabinet are well sealed;
  - 3) Check whether the power cable connection is loose, and then tighten it according to the torque specified before;
  - 4) Check whether the insulation wrapping tape of power cable terminal falls off;
- Check whether the grounding connection is correct and whether the grounding resistance value is not greater than 4Ω;

### 8.3 Maintenance of cabinet

#### 8.3.1 Clean surface of box free of dust

- 1) Scrub the dirty parts on the surface with a rag (or other scrubbing tools) dipped with water;
- 2) If it cannot be scrubbed clean with water, scrub it with 97% alcohol until the surface cleanliness is acceptable.

#### 8.3.2 Scratches on the surface of box

- 1) Polish the burr or scratch on the surface paint with sandpaper to make the surface smooth;
- 2) Scrub the damaged parts with a rag dipped in water or 97% alcohol to remove surface stains;
- 3) After the surface is dry, repaint the scratched point with a soft brush evenly and consistently.



#### 8.3.3 Paint shedding of box

- 1) Polish the damaged parts of paint with a sandpaper to remove rust and other burrs on the surface and make the surface smooth;
- 2) Scrub the damaged parts with a rag dipped in water or 97% alcohol to remove surface stains and dust;
- 3) After the surface is dried, spray zinc-rich primer on the exposed base material for protection. Spraying shall completely cover the bare substrate;
- 4) After the primer is dry, repaint the scratched point with a soft brush evenly and consistently.



Check the protective paint sprayed on the shell of energy storage integrated system for shedding. Please repair it in time, and respray the special protective paint on the outside of the energy storage integrated system every 5 years.

#### 8.3.4 Inspection of door locks, hinges and sealing strips

After cleaning, check whether the door locks and hinges of the energy storage integrated system can be used normally and in good condition. If necessary, properly lubricate the lock keyhole, hinge, etc.

The sealing strip in good condition is an important guarantee to effectively prevent water seepage inside the container. Be sure to check the sealing strip carefully and replace the damaged one immediately.

### 8.4 Maintenance of equipment

- 1) Suggested ambient temperature: 0 °C ~ 45 °C. Keep the charge and discharge temperature at 15 °C ~ 30 °C where the typical value is 25 °C;
- 2) Avoid charging and discharging RACK at a large rate. The continuous charge and discharge current of a single RACK shall not exceed the rated current;
- 3) When the battery energy storage system is left unused for a long time, the charge and discharge the system every 6 months to make the SOC of system reach 30% ~ 40%, and the SOC shall keep consistent after the charge;
- 4) Before the first use after long-term storage, charge the system fully at least once to restore the performance of battery to the best status;
- 5) Regularly check whether the air duct of heat dissipation system is blocked, clean the system regularly, be sure to clean the air inlet and outlet of fan, and clean it with a vacuum cleaner if necessary to ensure that the air can circulate freely in the cabinet. Cut off the power before the dust removal, and do not wash it with water;
- 6) Regularly check whether the fastening bolts of high-voltage cable and connecting bar of battery energy storage system are loose, whether the contact is good, and whether the terminal surface is seriously corroded or oxidized;
- 7) Regularly check whether the cable is loose, aged, damaged and broken, and whether the insulation is good;
- 8) Regularly check and monitor whether the voltage, temperature and other data of the upper computer are normal, and whether the alarm column has anomaly alarm;
- 9) Regularly check whether the fire fighting system is in good condition and within the validity period;
- 10) Do not use different types of battery modules in series or in parallel, and do not exchange PACK A and PACK B.



## 9 Appendices

### A. Technical Parameters

#### BYHV-230SAC



##### AC Parameters

Rated Power	100kW
Rated Voltage	AC 380V to 415V
Rated Current	150A
Rated Frequency	50Hz/60Hz
Power Factor	0.99
Output Harmonics	< 3%
Access mode	3P+N+PE
Isolation Method	Non-isolation

##### DC Parameters

Battery Type	300Ah, LFP battery
Group mode of battery	1P240S (1P24S*10)
Battery Rated Capacity	230.4kWh
Battery Rated Voltage	768V
Battery Voltage Range	628V to 855V
Rated charge and discharge current	150A
Cycles	≥8,000 (25°C, 0.5C, 80% DOD)

##### System Parameters

System Energy Efficiency	≥90%
Operating Modes	On-grid/off-grid
Communication mode	CAN, 485, TCP/IP
IP grade	IP55
Anti-corrosion grade	C3
Noise	≤65dB
Fire fighting	Hot aerosol
Ambient temperature	-29°C ~ +50°C
Ambient humidity	0% ~ 95% (no condensation)
Altitude	≤2,000m (derating above 2,000m)
Cooling mode	Intelligent Air Cooling
Overall Dimensions (WHD)	1130mm*2050mm*1865mm
Weight	About 2.6t



### B. Quality assurance

Our company will repair the products failed during the warranty period or replace them with new products free of charge.

#### Evidence

During the warranty period, our company requires the customers to show the invoices for purchased products. In addition, the trademark on the product shall be clearly visible. Otherwise the warrant may be invalid.

#### Condition

The nonconforming products after replacement shall be handled by our company;  
The customers shall give our company reasonable time to repair the faulty equipment.

#### Exemption

Our company is entitled not to provide the warranty under the following conditions:

- Whole machine and components have exceeded the free warranty period;
- Transportation damage;
- Incorrect installation, modification or use;
- Operation under very harsh conditions beyond the description in this manual;
- Machine failure or damage caused by installation, maintenance, modification or disassembly of the people other than service personnel of our company;
- Any installation and use beyond the scope specified in relevant international standards;
- Damage caused as result of abnormal natural environment.

For the product fault caused by the above situation, if the customer requires maintenance service, our company can provide the paid repair service after the judgment made by the service organization of our company

In order to continuously improve the customer satisfaction, our products and manuals are in continuous improvement and upgrading. If the version of manual is inconsistent with the product, the product in kind shall prevail. For any doubt, please contact our company.